

NJL7302L-F3/F5

■ ABSOLUTE MAXIMUM RATINGS (Ta=25°C)

PARAMETER	SYMBOL	RATINGS	UNIT
Collector - Emitter Voltage	V_{CEO}	15	V
Emitter - Collector Voltage	V_{ECO}	3	V
Power Dissipation	P_D	150	mW
Operating Temperature	T_{opr}	-30 to +70	°C
Storage Temperature	T_{stg}	-40 to +100	°C
Soldering Temperature	T_{sol}	260	°C

■ ELECTRO-OPTICAL CHARACTERISTICS (Ta=25°C)

PARAMETER	SYMBOL	TEST CONDITION	MIN	TYP	MAX	UNIT
Photocurrent	I_{L1}	$V_{CE}=5V$, Light source A, 10Lux	—	20	—	μA
	I_{L2}	$V_{CE}=5V$, White LED, 10Lux	10	20	50	μA
Comparison	I_{L2} / I_{L1}	—	—	1	—	—
Dark Current	I_D	$V_{CE}=5V$	—	—	100	nA
Collector-Emitter saturation voltage	$V_{ce(sat)}$	$I_L=6\mu A$ $E_v=10Lux$	—	—	1.4	V
Peak Wavelength	λ_p	—	—	550	—	nm
Half Angle	$\Theta_{1/2}$	NJL7302L-F3	—	± 55	—	deg.
		NJL7302L-F5	—	± 45	—	
IR reduction ratio	IR_re	Relative sensitivity(%)@850nm $\lambda_p=100\%$	—	0.007	—	%

* Please be aware that TYP value in Electro-Optical Characteristics is just for reference and is not guarantee.

■ TYPICAL CHARACTERISTICS

Light Current vs. Illuminance

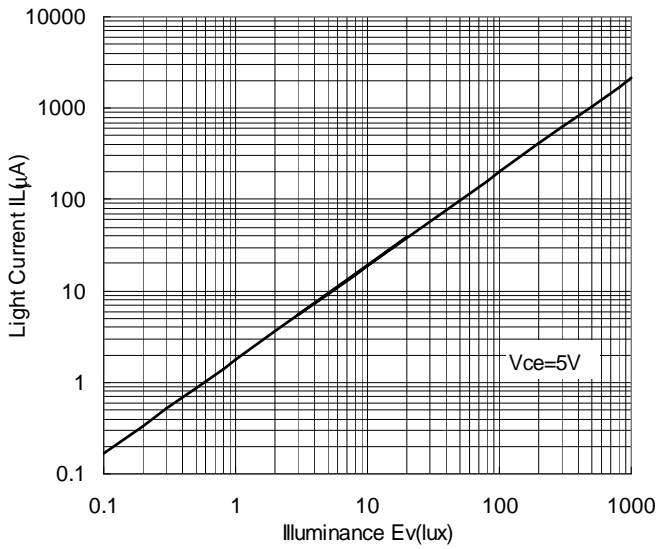

Light Current vs. Collector-Emitter Voltage

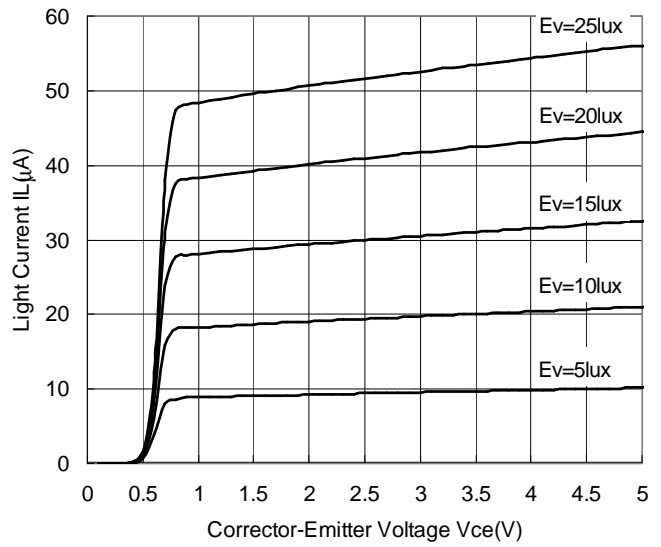

Relative Light Current vs. Temperature

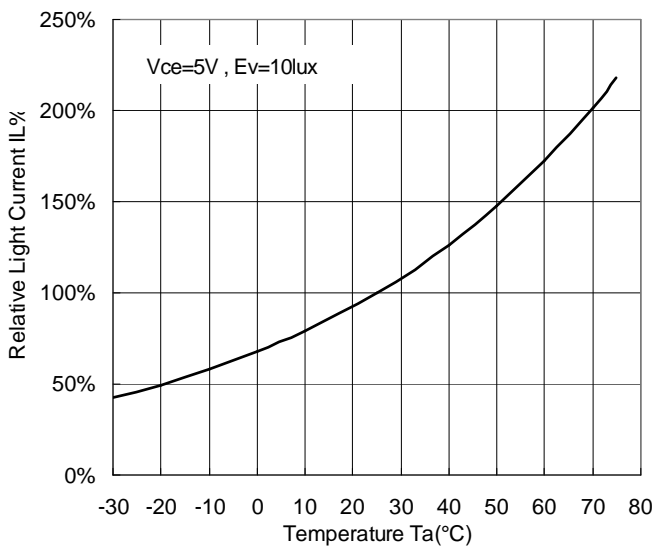

Dark Current vs. Temperature

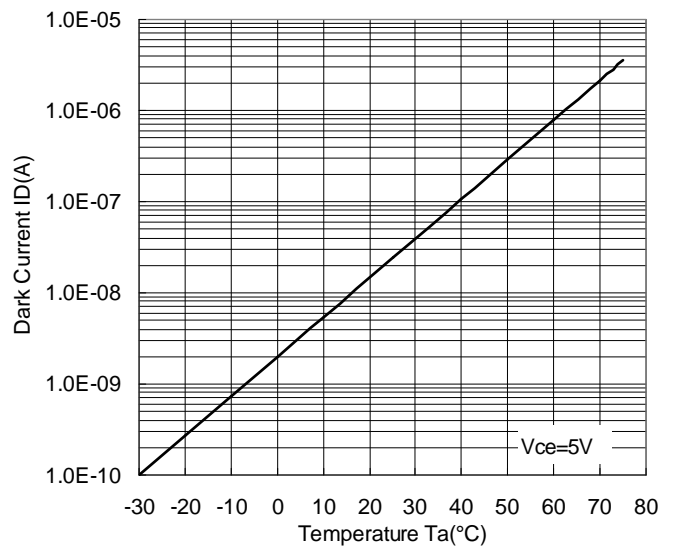

Directivity

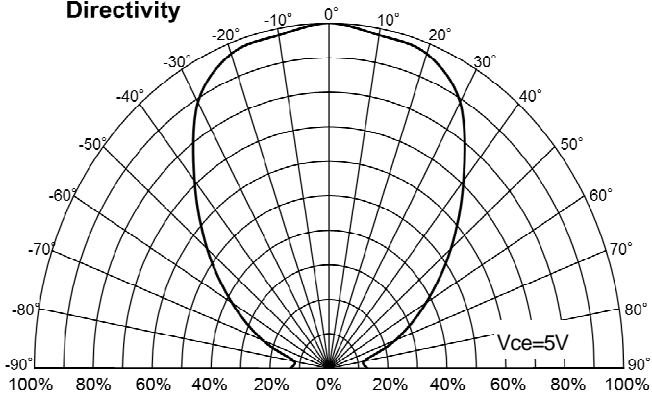

NJL7302L-F3

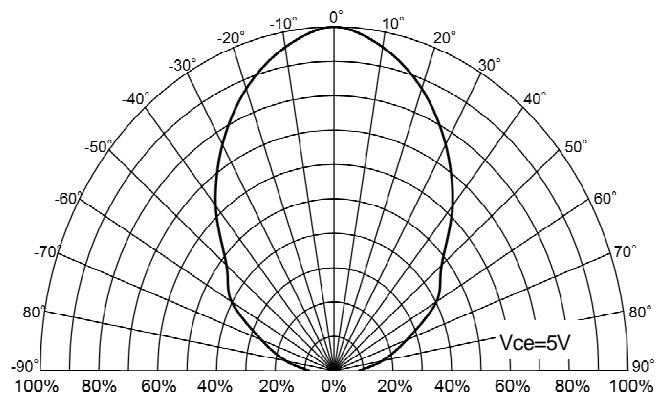

NJL7302L-F5

NJL7302L-F3/F5

Spectral Response

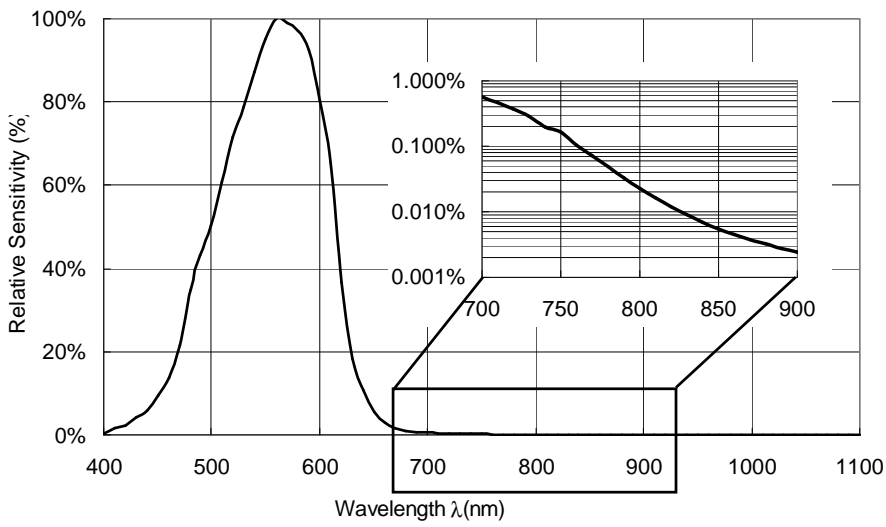

Resistance to optical noise of AC lamps

[measuring for AC lamp immunity]

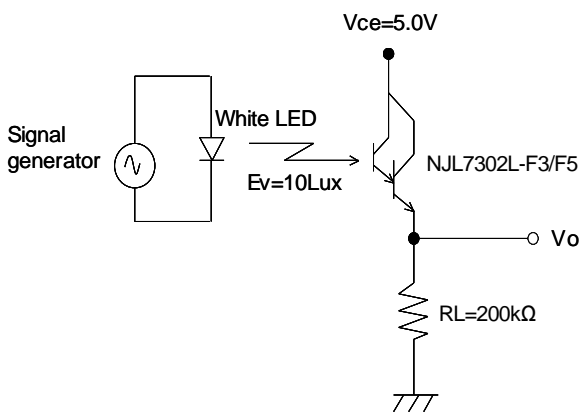

[light wave vs. Vo(mon)]

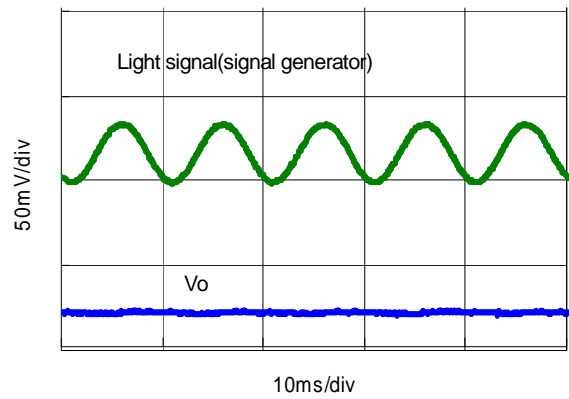

■ APPRICATION CIRCUIT (with Temperature Compensation Circuit (TCC))

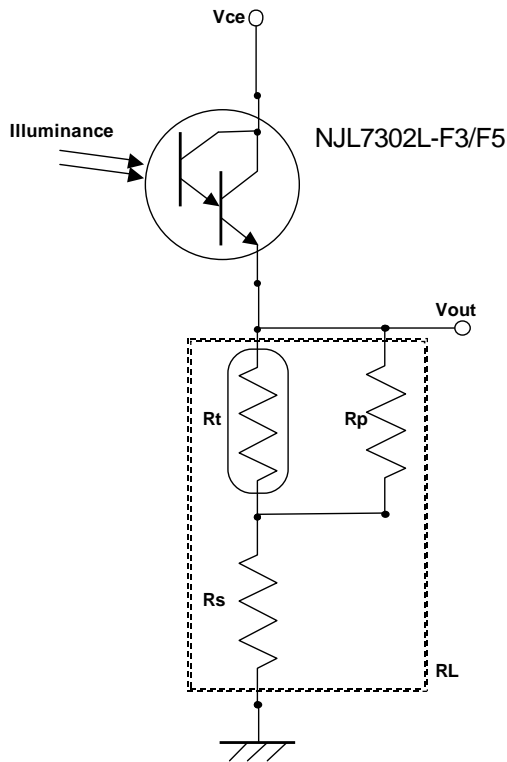

Rt :NTC Thermistor NCP18 Series (muRata)
 Rs:Chip Resistance MCR03 F Series (Rohm)
 Rp:Chip Resistance MCR03 F Series (Rohm)

Example

Condition : Vce=5V , Ev=5lux , Vout=1.0V

Rt	100k Ω
Rs	33k Ω
Rp	180k Ω

Temperature vs. Vadj

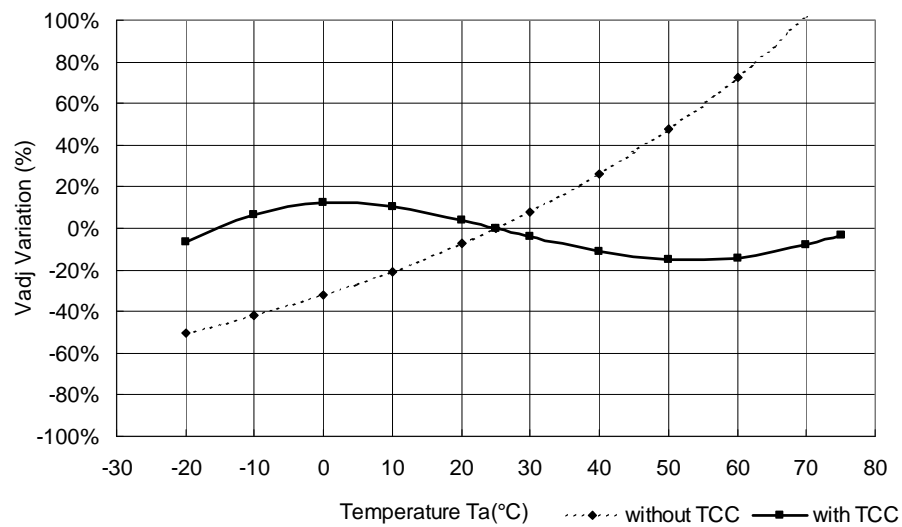

NJL7302L-F3/F5

■ POWER DISSIPATION VS. AMBIENT TEMPERATURE

Please, refer to the following Power Dissipation and Ambient Temperature.

(Please note a special attention should be paid in designing of thermal radiation.)

Power Dissipation - Ambient Temperature Characteristic

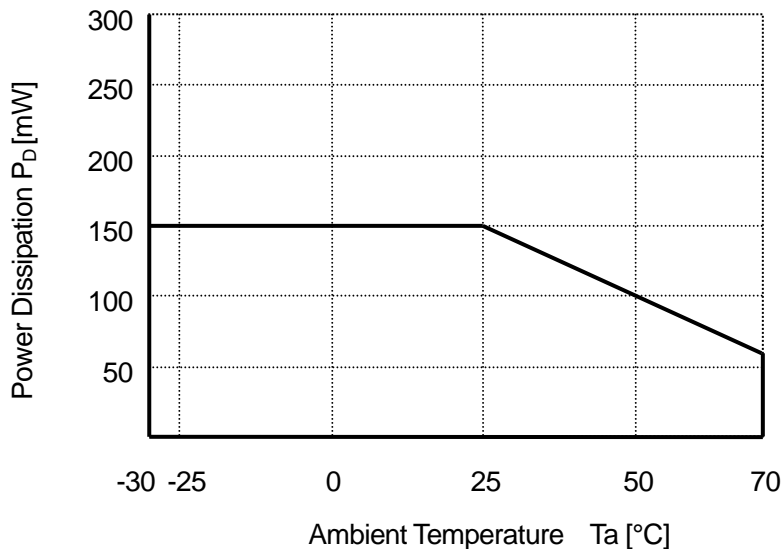

■ APPLICATION NOTES

Attention in handling

- (1) Treat not to touch the lens surface.
- (2) Avoid dust and any other foreign materials (flux, paints, bonding material, etc) on the lens surface.
- (3) Never to apply reverse voltage (V_{EC}) of more than 2V on the photo transistor when measuring the characteristics or adjusting the system. If applied, it causes to lower the sensitivity.
- (4) When mounting, special care has to be taken on the mounting position and tilting of the device because it is very important to place the device to the optimum position to the object.
- (5) Take care about rust of tiebar part. Because the tiebar is cut off that tiebar part of lead is not plated.

■ PACKING SPECIFICATION

《PHOTO TRANSISTOR PACKING SPECIFICATION》 UNIT : m m

【VINYL BAG SPECIFICATION】

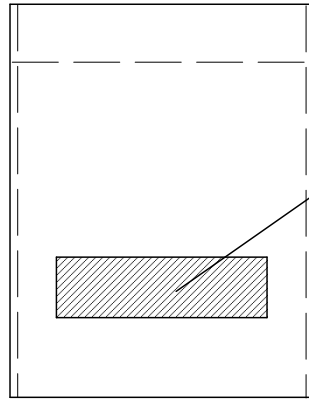

【Label】

Device No., Quantity, Lot No.

Material: Antistatic vinyl

Sealing: Heat seal

Contents: 1000pcs / bag (NJL7302L-F3)

500pcs / bag (NJL7302L-F5)

【OUTER PACKING SPECIFICATION】

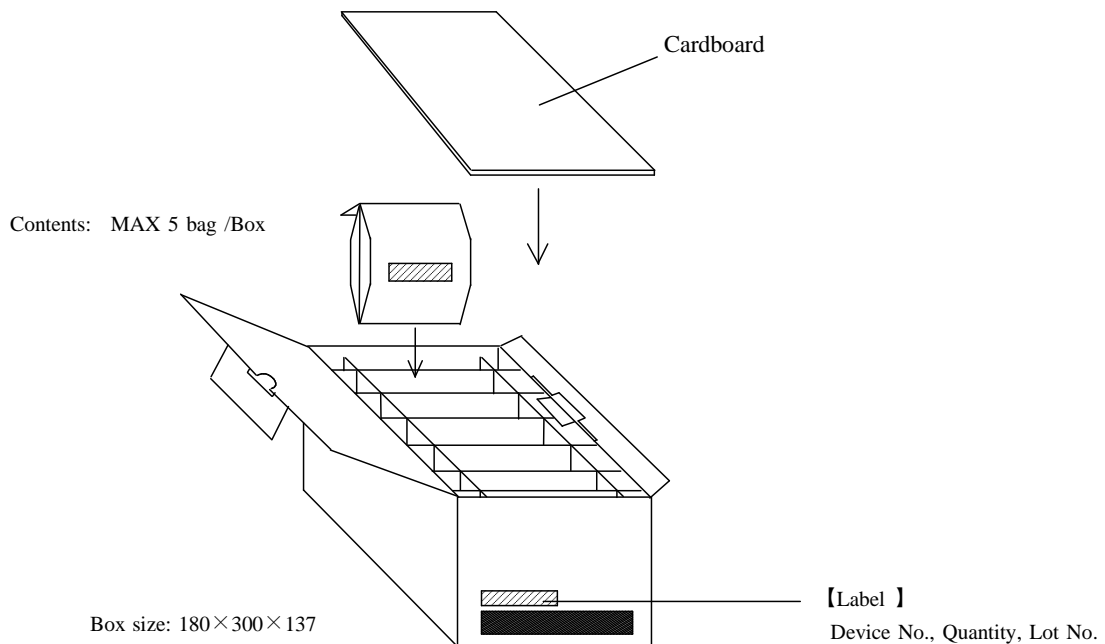

NJL7302L-F3/F5

■ MOUNTING METHOD

NOTE

Mounting was evaluated with the following profiles in our company, so there was no problem.
However, confirm mounting by the condition of your company beforehand.

Mounting: Twice soldering is allowed.

REFLOW SOLDERING METHOD

*Reflow soldering is not possible.

FLOW SOLDERING METHOD

* Flow soldering procedure

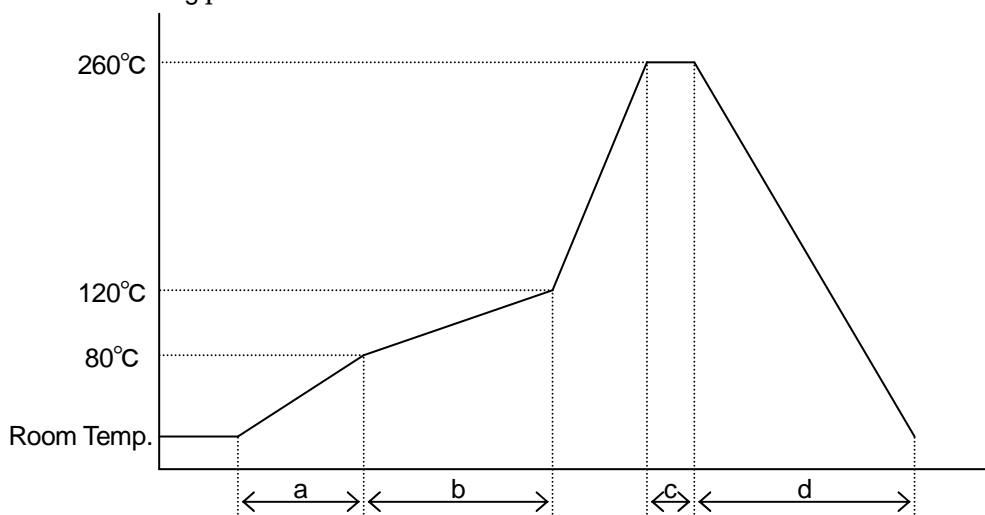

- a : Temperature ramping rate : 1 to 7°C/s
- b : Pre-heating temperature : 80 to 120°C
Pre-heating time : 60 to 120s
- c : Peak temperature : not exceeding 260°C
Peak time : within 10s/Pin
- d : Temperature ramping rate : 1 to 7°C/s

The temperature indicates at the terminals.

* Soldering Position: At least 3mm from body. (Prevent the body temperature to rise as much as possible.)

- The resin gets softened right after soldered, so, the following care has to be taken.
 - Not to contact the lens surface to anything.
 - Not to dip the device into water or any solvents.
- It is recommended not to solder when the leads or between the lead get pulled, depressed or twisted.

IRON SOLDERING METHOD

* Recommended Iron Soldering conditions

Temperature of Iron : 350°C or less

Soldering time : within 3s (At a lead)

Soldering Position : At least 4mm away from body. (Prevent the temperature rise of the body.)

(Note1) Do not apply load to body and lead when soldering.

(Note2) Do not heat the whole body when soldering.

■ IC STORAGE CONDITION AND ITS DURATION

(1) Temperature and humidity ranges.

Temperature: 5 ~ 40 (°C)

Humidity : 30 ~ 75 (%)

Normally a package product does not have a quality problem such as package crack because of absorbing humidity. However, the above stated conditions are recommended for storage. Please note that an electrostatic discharge is apt to destroy the product under the dried environment below 30%.

It is also recommended to store the products avoiding the place where it creates dew with the products due to a sudden change in temperature.

(2) Please do not expose the products in the corrosive atmosphere.

(3) Please store the products in dust free place.

(4) Please do not expose the products to a direct sun light.

(5) Please store the IC without adding a load.

(6) No need to worry about baking under above storage terms.

(7) The leads are silver plated and they are discolored if the device is left open to the air for long after taken out of the envelop. It causes deterioration of soldering characteristics. Mount the device as short as possible after opening the envelope.

■ STORAGE DURATION

Please store the products less than one year after opening the envelop is made.

For the products which storage duration are longer than one year, please check the solderability and if the leads are rusty before they are used.

[CAUTION]

The specifications on this databook are only given for information, without any guarantee as regards either mistakes or omissions. The application circuits in this databook are described only to show representative usages of the product and not intended for the guarantee or permission of any right including the industrial rights.

Mouser Electronics

Authorized Distributor

Click to View Pricing, Inventory, Delivery & Lifecycle Information:

[Nisshinbo Micro Devices:](#)

[NJL7302L-F3](#) [NJL7302L-F5](#)