



150 μV Maximum Offset Voltage Op Amp

OP07D

FEATURES

- Low offset voltage: 150 μV max
- Input offset drift: 1.5 $\mu\text{V}/^\circ\text{C}$ max
- Low noise: 0.25 μV p-p
- High gain CMRR and PSRR: 115 dB min
- Low supply current: 1.1 mA
- Wide supply voltage range: $\pm 4\text{ V}$ to $\pm 18\text{ V}$ operation

APPLICATIONS

- Medical and industrial instrumentation
- Sensors and controls
 - Thermocouple
 - RTDs
 - Strain bridges
 - Shunt current measurements
- Precision filters

GENERAL DESCRIPTION

The OP07D is a precision, ultralow offset amplifier. It integrates low power (1.1 mA typical), low input bias current ($\pm 1\text{ nA}$ maximum), and high CMRR/PSRR (130 dB) in the small DIP package. Operation is fully specified from $\pm 5\text{ V}$ to $\pm 15\text{ V}$ supply.

The OP07D provides higher accuracy than industry-standard OP07-type amplifiers due to Analog Devices' iPolar™ process, which supports enhanced performance in a smaller footprint. These performance enhancements include wider output swing, lower power, and higher CMRR (common-mode rejection ratio) and PSRR (power supply rejection ratio). The OP07D maintains stability of offsets and gain virtually regardless of variations in time or temperature. Excellent linearity and gain accuracy can be maintained at high closed-loop gains.

The OP07D is fully specified over the extended industrial temperature range of -40°C to $+125^\circ\text{C}$. The OP07D amplifier is available in 8-lead DIP and the popular 8-lead, narrow SOIC lead-free packages.

PIN CONFIGURATIONS

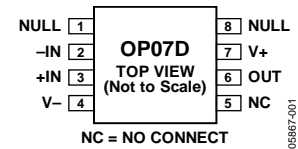

Figure 1. 8-Lead SOIC_N (R-8), 8-Lead DIP (N-8)

Rev. A

Information furnished by Analog Devices is believed to be accurate and reliable. However, no responsibility is assumed by Analog Devices for its use, nor for any infringements of patents or other rights of third parties that may result from its use. Specifications subject to change without notice. No license is granted by implication or otherwise under any patent or patent rights of Analog Devices. Trademarks and registered trademarks are the property of their respective owners.

One Technology Way, P.O. Box 9106, Norwood, MA 02062-9106, U.S.A.
Tel: 781.329.4700 www.analog.com
Fax: 781.461.3113 © 2005–2011 Analog Devices, Inc. All rights reserved.

TABLE OF CONTENTS

Features	1	Absolute Maximum Ratings	5
Applications.....	1	Thermal Resistance	5
General Description	1	ESD Caution.....	5
Pin Configurations	1	Typical Performance Characteristics	6
Revision History	2	Outline Dimensions	13
Specifications.....	3	Ordering Guide	14

REVISION HISTORY

2/11—Rev. 0 to Rev. A

Changes to Output Voltage Swing Parameter.....	4
Changes to Figure 42.....	12
Updated Outline Dimensions	13
Changes to Ordering Guide	14

12/05—Revision 0: Initial Version

SPECIFICATIONS

$V_S = \pm 5.0\text{ V}$, $T_A = 25^\circ\text{C}$, unless otherwise specified.

Table 1.

Parameter	Symbol	Test Conditions/Comments	Min	Typ	Max	Unit
INPUT CHARACTERISTICS						
Offset Voltage	V_{OS}	$0^\circ\text{C} \leq T_A \leq 70^\circ\text{C}$		40	150	μV
		$-40^\circ\text{C} \leq T_A \leq +125^\circ\text{C}$			250	μV
Input Bias Current	I_B	$-40^\circ\text{C} \leq T_A \leq +125^\circ\text{C}$		0.2	1	nA
Input Offset Current	I_{OS}	$-40^\circ\text{C} \leq T_A \leq +125^\circ\text{C}$		0.1	1	nA
Input Voltage Range			-3.5		+3.5	V
Common-Mode Rejection Ratio	CMRR	$V_{CM} = \pm 3\text{ V}$	120	127		dB
		$-40^\circ\text{C} \leq T_A \leq +125^\circ\text{C}$	120			dB
Open-Loop Gain	A_{VO}	$R_L = 2\text{ k}\Omega$ to ground, $V_O = \pm 3\text{ V}$	1000	10,000		V/mV
		$-40^\circ\text{C} \leq T_A \leq +125^\circ\text{C}$	1000			V/mV
Offset Voltage Drift	$\Delta V_{OS}/\Delta T$	$0^\circ\text{C} \leq T_A \leq 70^\circ\text{C}$		0.5	1.8	$\mu\text{V}/^\circ\text{C}$
		$-40^\circ\text{C} \leq T_A \leq +125^\circ\text{C}$		0.5	1.4	$\mu\text{V}/^\circ\text{C}$
OUTPUT CHARACTERISTICS						
Output Voltage Swing	V_{OUT}	$R_L = 10\text{ k}\Omega$ to ground	± 3.95	± 4.1		V
		$-40^\circ\text{C} \leq T_A \leq +125^\circ\text{C}$	± 3.95			V
		$R_L = 2\text{ k}\Omega$ to ground	± 3.9	± 4		V
		$-40^\circ\text{C} \leq T_A \leq +125^\circ\text{C}$	± 3.9			V
Short-Circuit Current	I_{SC}			27		mA
Output Current	I_O	$V_O = 3.5\text{ V}$		15		mA
POWER SUPPLY						
Power Supply Rejection Ratio	PSRR	$V_S = \pm 4.0\text{ V}$ to $\pm 18.0\text{ V}$	115	130		dB
		$0^\circ\text{C} \leq T_A \leq 70^\circ\text{C}$	115			dB
		$-40^\circ\text{C} \leq T_A \leq +125^\circ\text{C}$	110			dB
Supply Current/Amplifier	I_{SY}	$V_O = 0\text{ V}$		1.1	1.25	mA
		$0^\circ\text{C} \leq T_A \leq 70^\circ\text{C}$			1.45	mA
		$-40^\circ\text{C} \leq T_A \leq +125^\circ\text{C}$			1.75	mA
DYNAMIC PERFORMANCE						
Slew Rate	SR	$R_L = 10\text{ k}\Omega$		0.2		V/ μs
Gain Bandwidth Product	GBP			0.6		MHz
Phase Margin				80		Degrees
NOISE PERFORMANCE						
Voltage Noise	$e_{n\text{ p-p}}$	0.1 Hz to 10 Hz		0.28		$\mu\text{V p-p}$
Voltage Noise Density	e_n	$f = 1\text{ kHz}$		10		nV/ $\sqrt{\text{Hz}}$
Current Noise Density	i_n	$f = 1\text{ kHz}$		0.074		pA/ $\sqrt{\text{Hz}}$

OP07D

$V_s = \pm 15\text{ V}$, $T_A = 25^\circ\text{C}$, unless otherwise specified.

Table 2.

Parameter	Symbol	Test Conditions/Comments	Min	Typ	Max	Unit
INPUT CHARACTERISTICS						
Offset Voltage	V_{OS}	$0^\circ\text{C} \leq T_A \leq 70^\circ\text{C}$ $-40^\circ\text{C} \leq T_A \leq +125^\circ\text{C}$		45	150	μV
					250	μV
					350	μV
Input Bias Current	I_B	$-40^\circ\text{C} \leq T_A \leq +125^\circ\text{C}$		0.2	1	nA
Input Offset Current	I_{OS}	$-40^\circ\text{C} \leq T_A \leq +125^\circ\text{C}$		0.2	1	nA
					1	nA
Input Voltage Range			-13.5		+13.5	V
Common-Mode Rejection Ratio	CMRR	$V_{CM} = \pm 13.0\text{ V}$ $-40^\circ\text{C} \leq T_A \leq +125^\circ\text{C}$	120	140		dB
Open-Loop Gain	A_{VO}	$R_L = 2\text{ k}\Omega$ to ground, $V_O = \pm 11\text{ V}$ $-40^\circ\text{C} \leq T_A \leq +125^\circ\text{C}$	1000	10,000		V/mV
			1000			V/mV
Offset Voltage Drift	$\Delta V_{OS}/\Delta T$	$0^\circ\text{C} \leq T_A \leq 70^\circ\text{C}$ $-40^\circ\text{C} \leq T_A \leq +125^\circ\text{C}$		0.5	2.5	$\mu\text{V}/^\circ\text{C}$
				0.5	1.5	$\mu\text{V}/^\circ\text{C}$
OUTPUT CHARACTERISTICS						
Output Voltage Swing	V_{OUT}	$R_L = 10\text{ k}\Omega$ to ground $-40^\circ\text{C} \leq T_A \leq +125^\circ\text{C}$ $R_L = 2\text{ k}\Omega$ to ground $-40^\circ\text{C} \leq T_A \leq +125^\circ\text{C}$	± 13.95 ± 13.9 ± 13.75 ± 13.7	± 14 ± 13.8 		V V V V
Short-Circuit Current	I_{SC}			30		mA
Output Current	I_O	$V_O = 13.5\text{ V}$		15		mA
POWER SUPPLY						
Power Supply Rejection Ratio	PSRR	$V_s = \pm 4.0\text{ V}$ to $\pm 18.0\text{ V}$ $0^\circ\text{C} \leq T_A \leq 70^\circ\text{C}$ $-40^\circ\text{C} \leq T_A \leq +125^\circ\text{C}$	115 115 110	130		dB dB dB
Supply Current/Amplifier	I_{SV}	$V_O = 0\text{ V}$ $0^\circ\text{C} \leq T_A \leq 70^\circ\text{C}$ $-40^\circ\text{C} \leq T_A \leq +125^\circ\text{C}$		1.1	1.3	mA
					1.55	mA
					1.85	mA
DYNAMIC PERFORMANCE						
Slew Rate	SR	$R_L = 10\text{ k}\Omega$		0.2		V/ μs
Gain Bandwidth Product	GBP			0.6		MHz
Phase Margin				80		Degrees
NOISE PERFORMANCE						
Voltage Noise	$e_{n\text{ p-p}}$	0.1 Hz to 10 Hz		0.25		$\mu\text{V p-p}$
Voltage Noise Density	e_n	$f = 1\text{ kHz}$		10		nV/ $\sqrt{\text{Hz}}$
Current Noise Density	i_n	$f = 1\text{ kHz}$		0.074		pA/ $\sqrt{\text{Hz}}$

ABSOLUTE MAXIMUM RATINGS

Table 3.

Parameter	Rating
Supply Voltage	±18 V
Input Voltage	±V supply
Differential Input Voltage	±0.7 V
Output Short-Circuit Duration to GND	Indefinite
Storage Temperature Range	−65°C to +150°C
Operating Temperature Range	−40°C to +125°C
Junction Temperature Range	−65°C to +150°C
Lead Temperature (Soldering, 10 sec)	+300°C

Stresses above those listed under Absolute Maximum Ratings may cause permanent damage to the device. This is a stress rating only; functional operation of the device at these or any other conditions above those indicated in the operational section of this specification is not implied. Exposure to absolute maximum rating conditions for extended periods may affect device reliability.

THERMAL RESISTANCE

θ_{JA} is specified for worst-case conditions, that is, a device soldered in a circuit board for surface-mount packages.

Table 4.

Package Type	θ_{JA}	θ_{JC}	Unit
8-Lead DIP (N-8)	103	43	°C/W
8-Lead SOIC (R-8)	158	43	°C/W

ESD CAUTION

ESD (electrostatic discharge) sensitive device. Electrostatic charges as high as 4000 V readily accumulate on the human body and test equipment and can discharge without detection. Although this product features proprietary ESD protection circuitry, permanent damage may occur on devices subjected to high energy electrostatic discharges. Therefore, proper ESD precautions are recommended to avoid performance degradation or loss of functionality.



TYPICAL PERFORMANCE CHARACTERISTICS

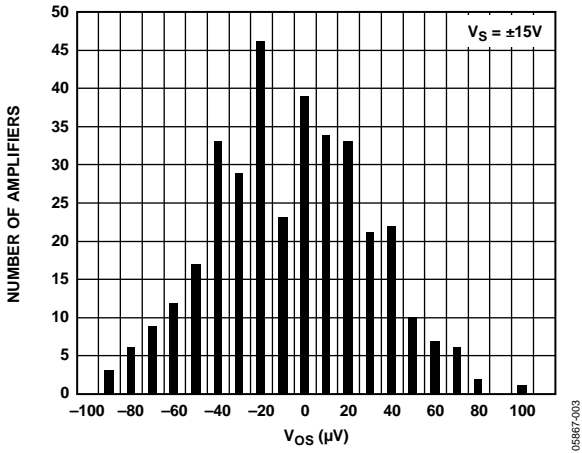

Figure 2. Number of Amplifiers vs. Offset Voltage

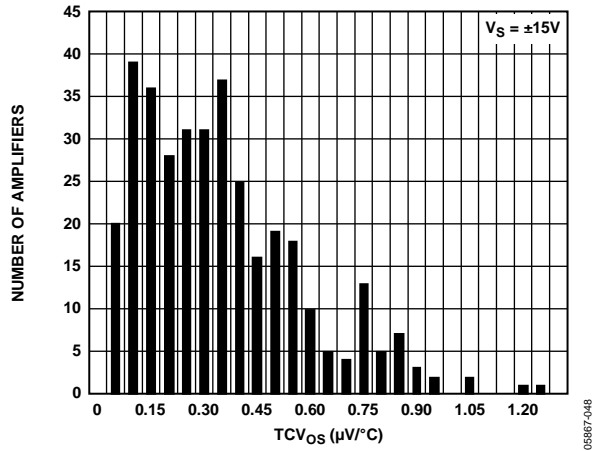

Figure 5. Number of Amplifiers vs. TCV_{OS}

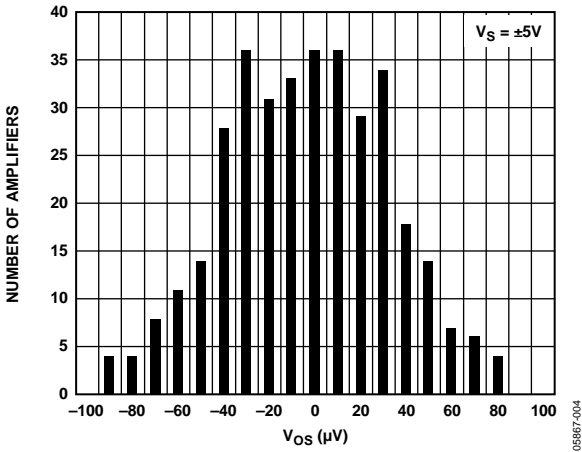

Figure 3. Number of Amplifiers vs. Offset Voltage

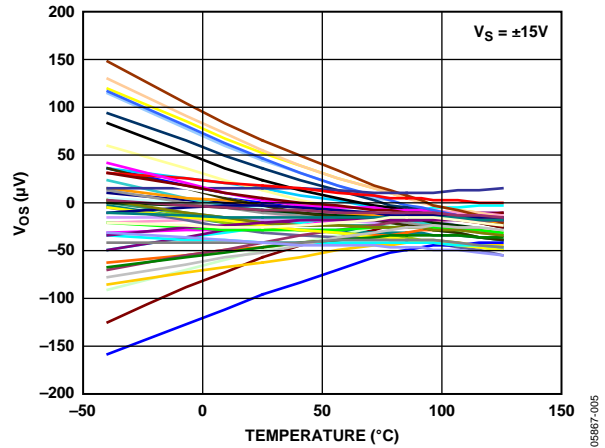

Figure 6. Offset Voltage vs. Temperature

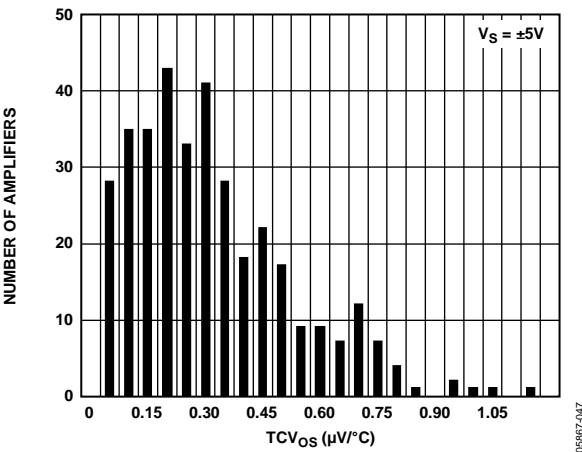

Figure 4. Number of Amplifiers vs. TCV_{OS}

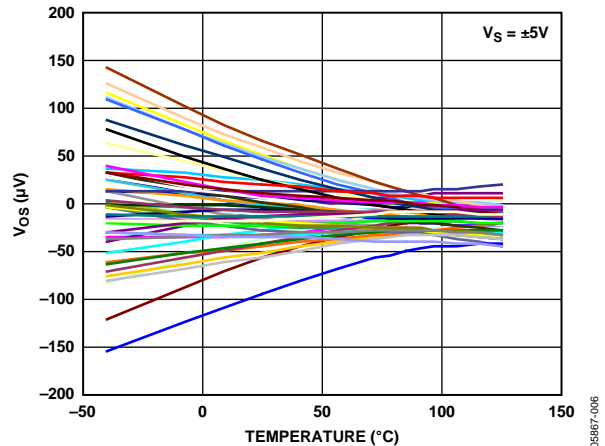

Figure 7. Offset Voltage vs. Temperature

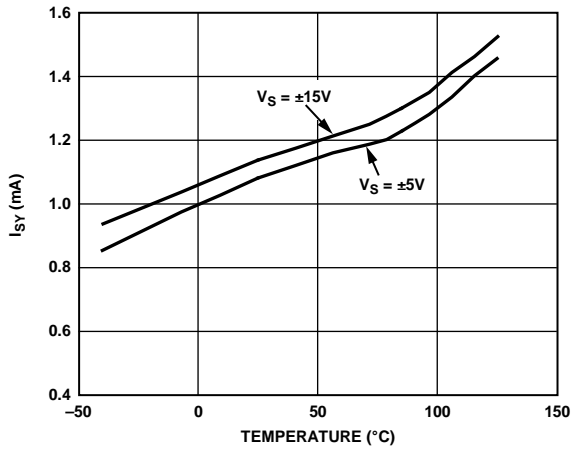

Figure 8. Supply Current vs. Temperature

05867-007

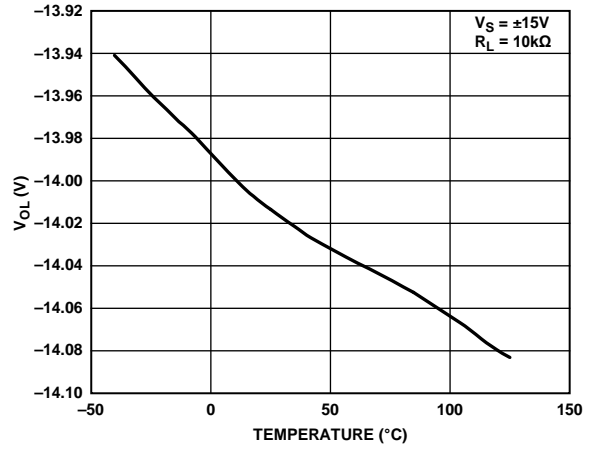

Figure 11. Negative Output Voltage Swing vs. Temperature

05867-011

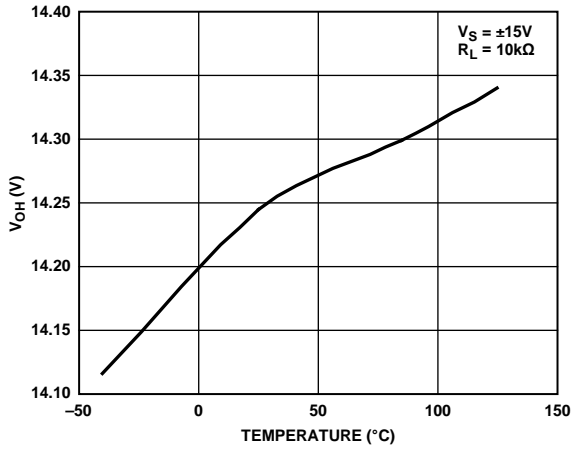

Figure 9. Positive Output Voltage Swing vs. Temperature

05867-009

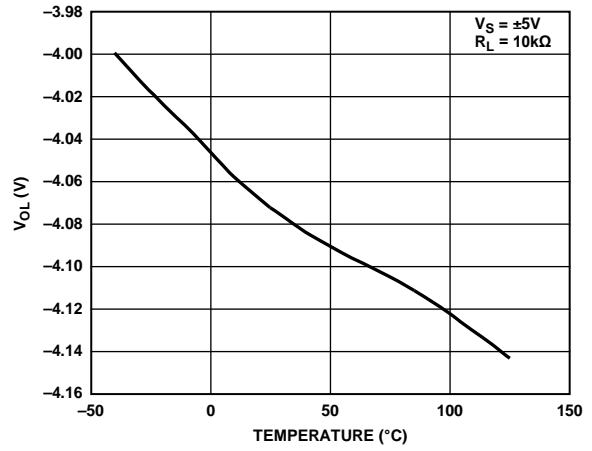

Figure 12. Negative Output Voltage Swing vs. Temperature

05867-012

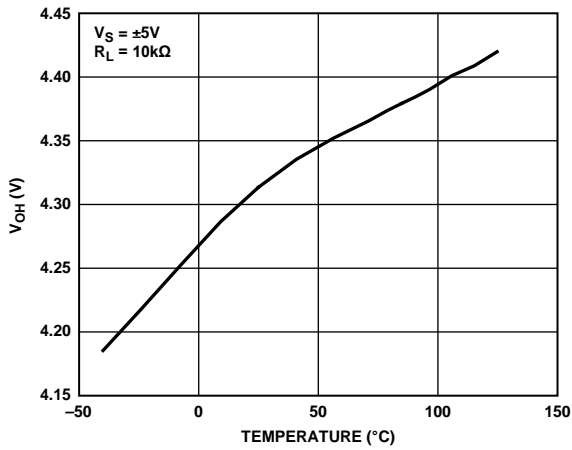

Figure 10. Positive Output Voltage Swing vs. Temperature

05867-010

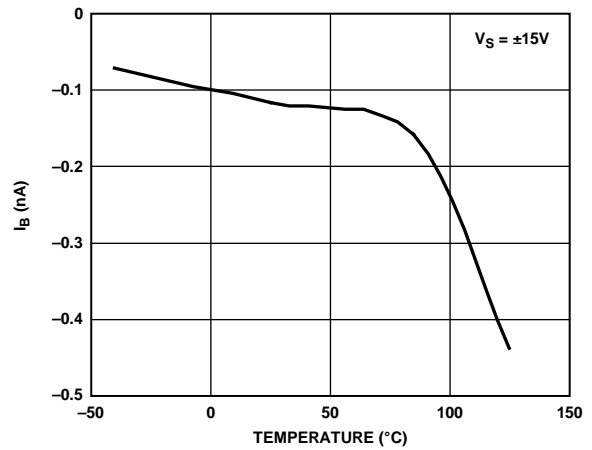

Figure 13. Input Bias Current vs. Temperature

05867-013

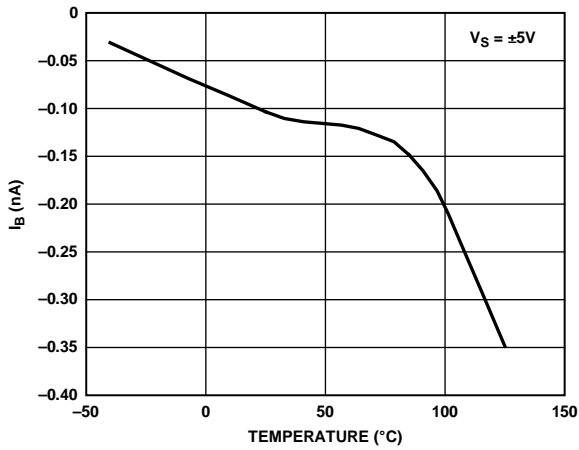

Figure 14. Input Bias Current vs. Temperature

05867-014

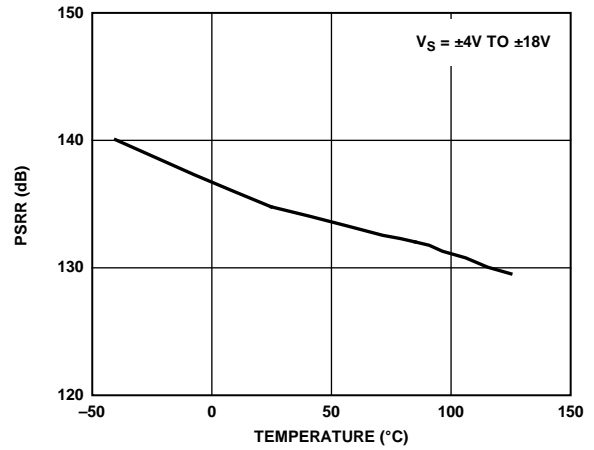

Figure 17. PSRR vs. Temperature

05867-019

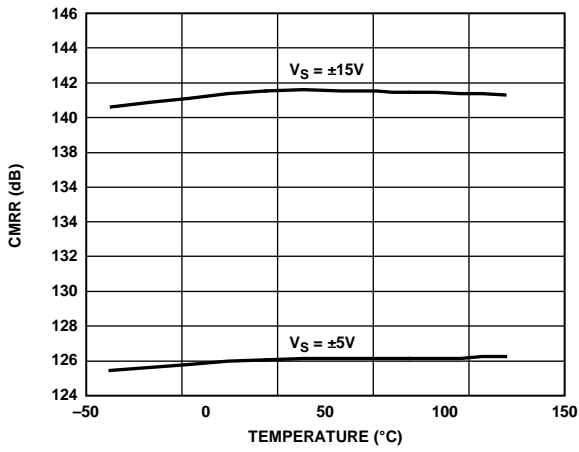

Figure 15. CMRR vs. Temperature

05867-015

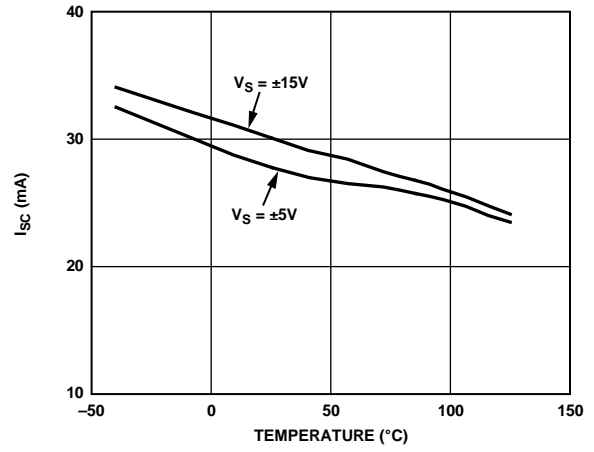

Figure 18. Short-Circuit Current vs. Temperature

05867-020

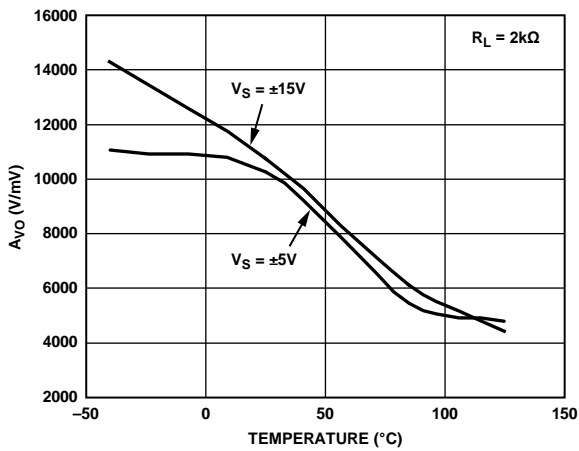

Figure 16. Open-Loop Gain vs. Temperature

05867-017

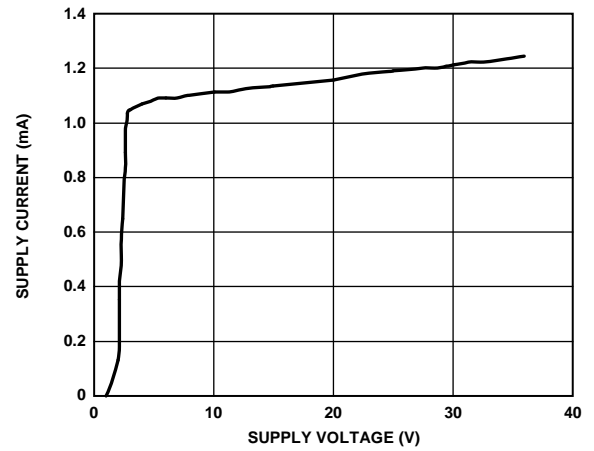

Figure 19. Supply Current vs. Supply Voltage

05867-022

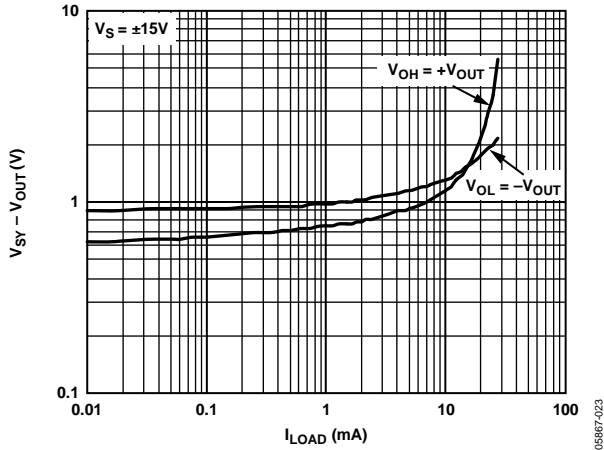

Figure 20. Output Voltage Swing vs. Load Current

05867-023

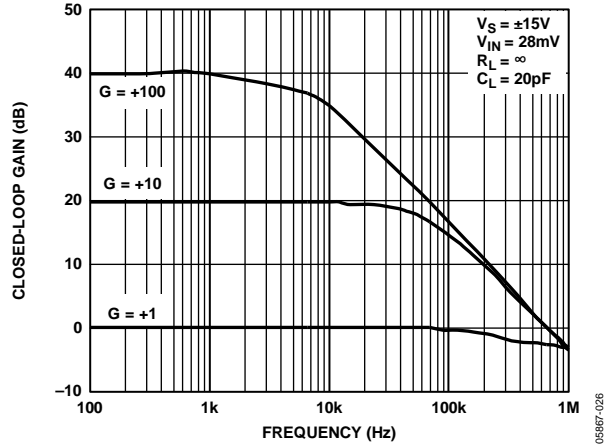

Figure 23. Closed-Loop Gain vs. Frequency

05867-026

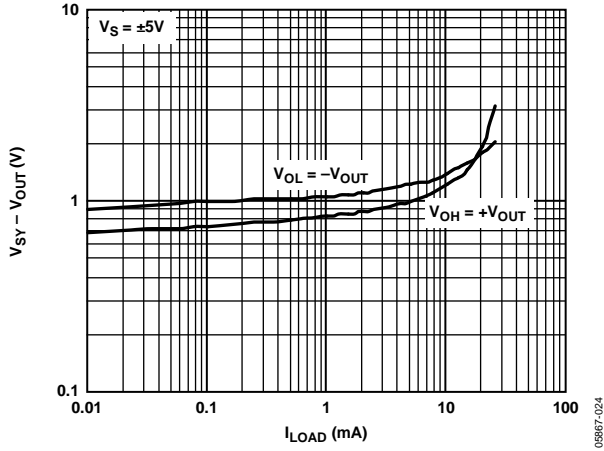

Figure 21. Output Voltage Swing vs. Load Current

05867-024

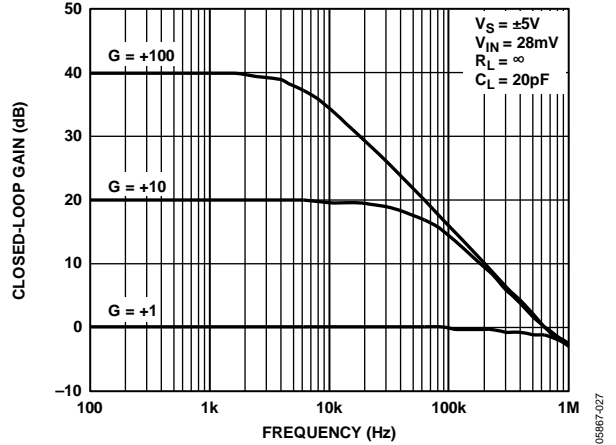

Figure 24. Closed-Loop Gain vs. Frequency

05867-027

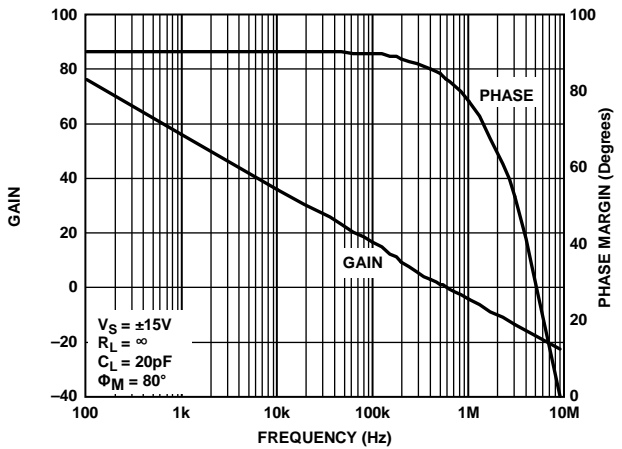

Figure 22. Open-Loop Gain and Phase vs. Frequency

05867-025

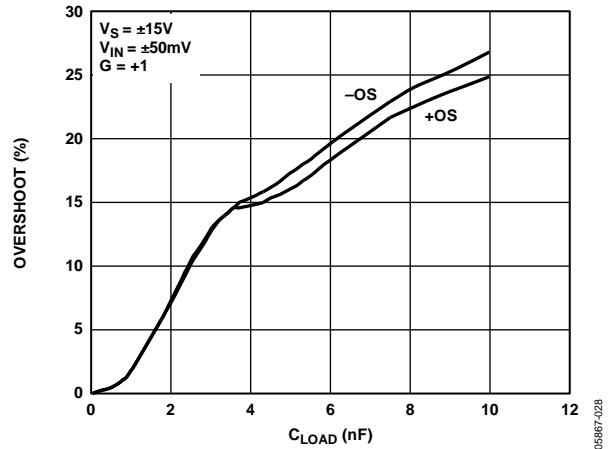

Figure 25. Overshoot vs. Capacitive Load

05867-028

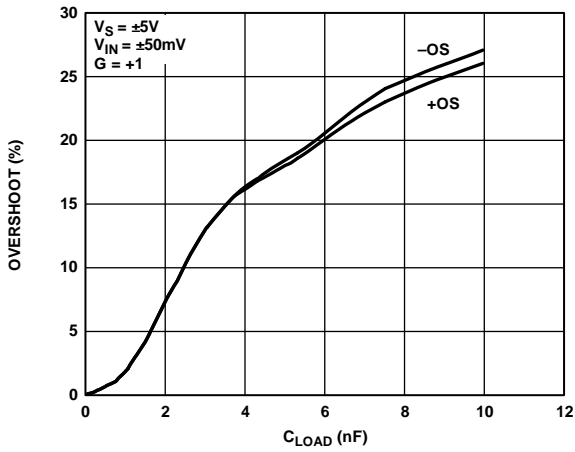

Figure 26. Overshoot vs. Capacitive Load

05867-029

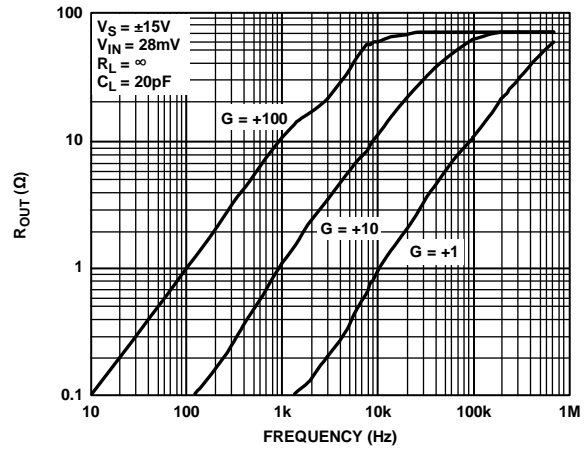

Figure 29. Output Impedance vs. Frequency

05867-032

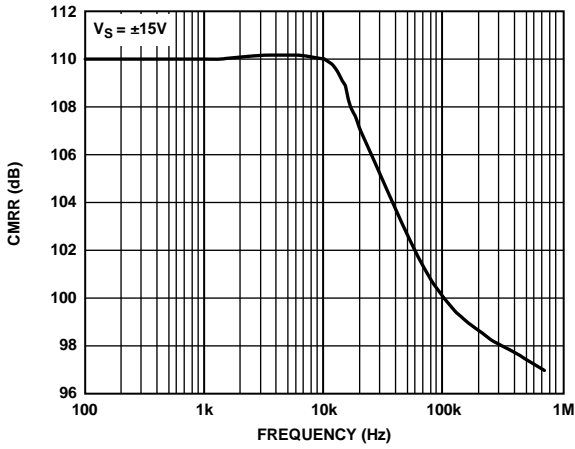

Figure 27. CMRR vs. Frequency

05867-030

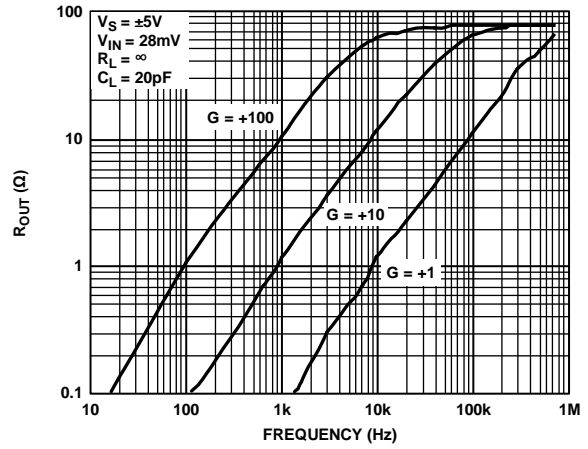

Figure 30. Output Impedance vs. Frequency

05867-033

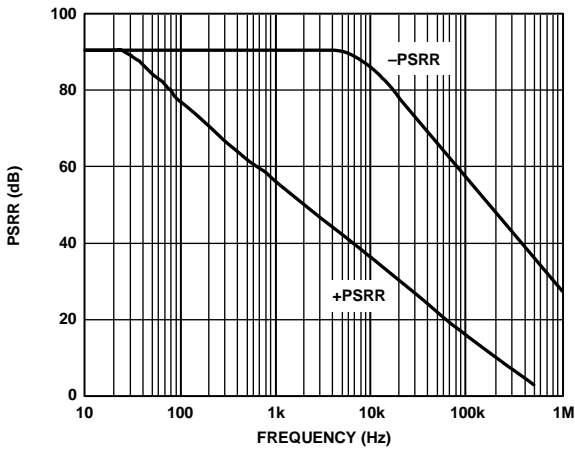

Figure 28. PSRR vs. Frequency

05867-031

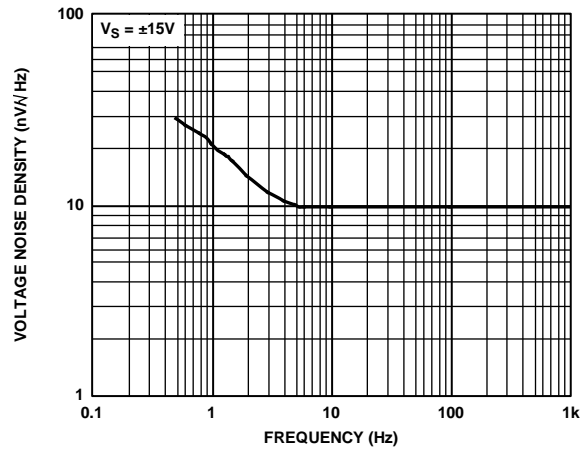

Figure 31. Voltage Noise Density vs. Frequency

05867-034

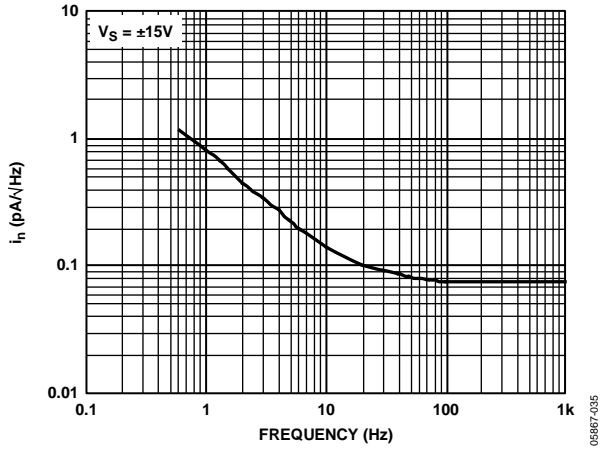

Figure 32. Current Noise Density vs. Frequency

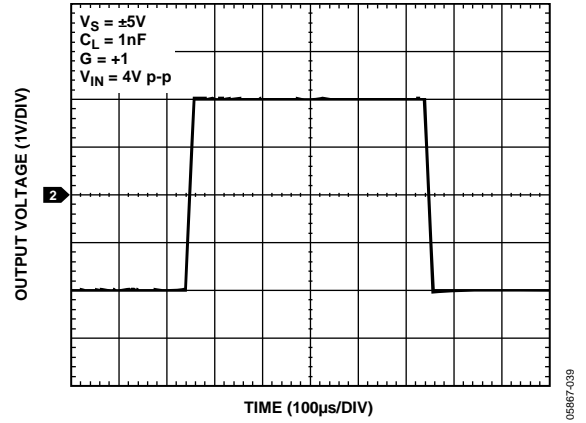

Figure 35. Large-Signal Transient

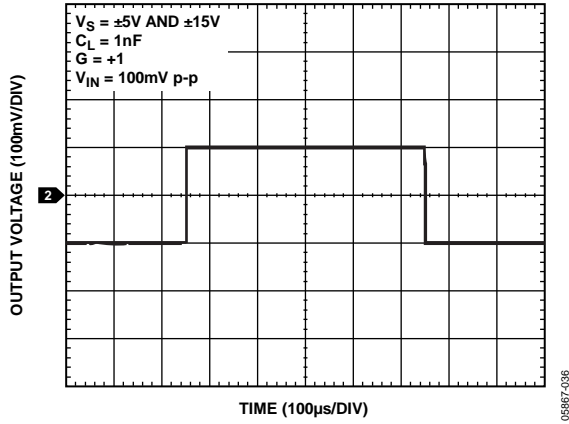

Figure 33. Small-Signal Transient

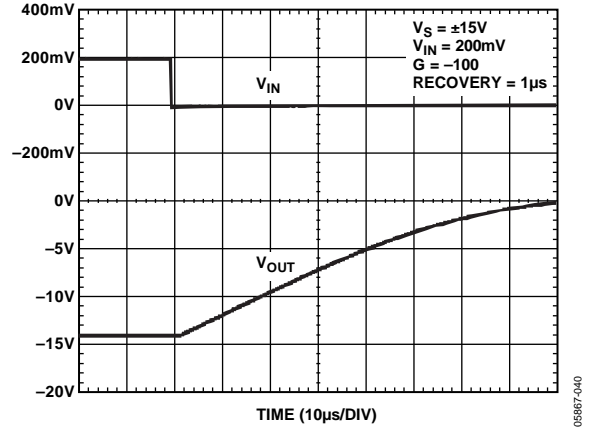

Figure 36. Positive Overload Recovery

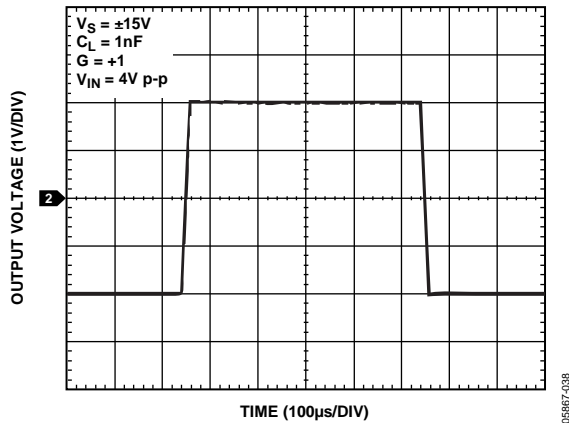

Figure 34. Large-Signal Transient

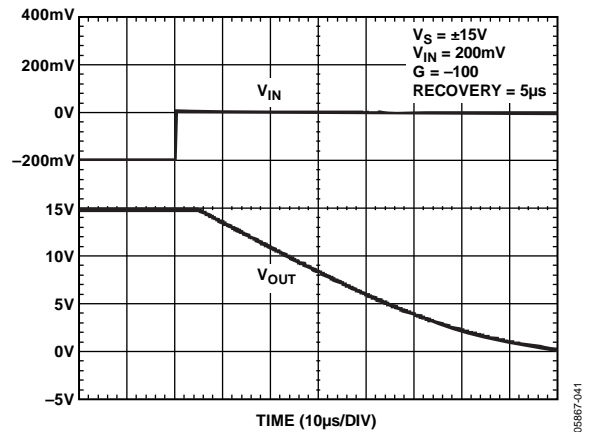

Figure 37. Negative Overload Recovery

OP07D

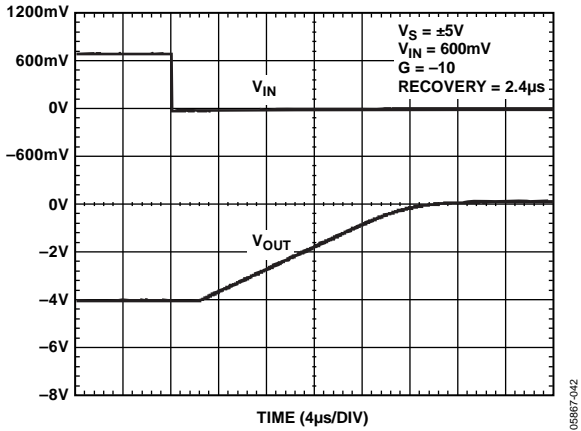

Figure 38. Positive Overload Recovery

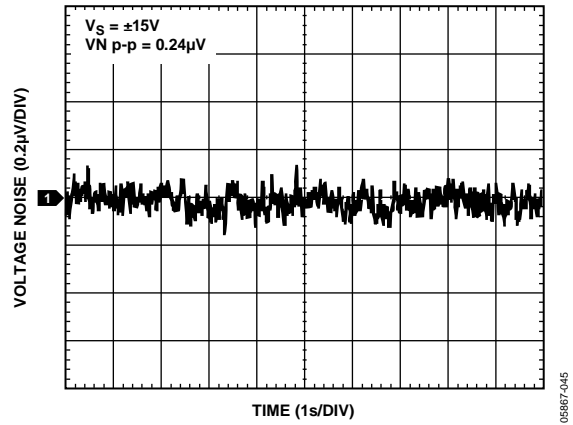

Figure 41. Voltage Noise (0.1 Hz to 10 Hz)

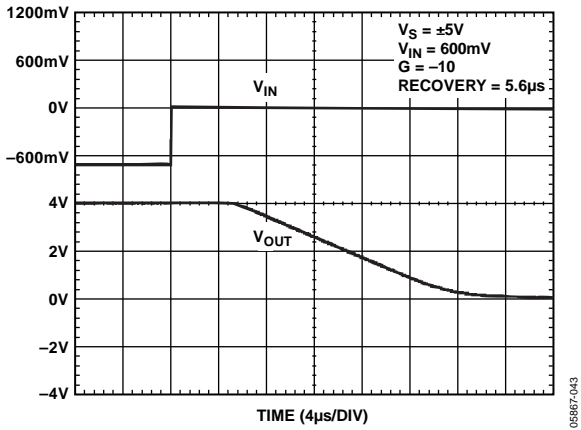

Figure 39. Negative Overload Recovery

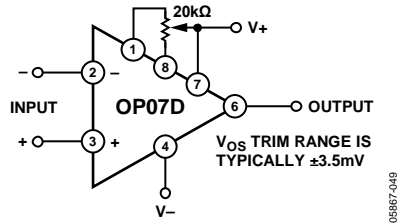

Figure 42. Optional Offset Nulling Circuit

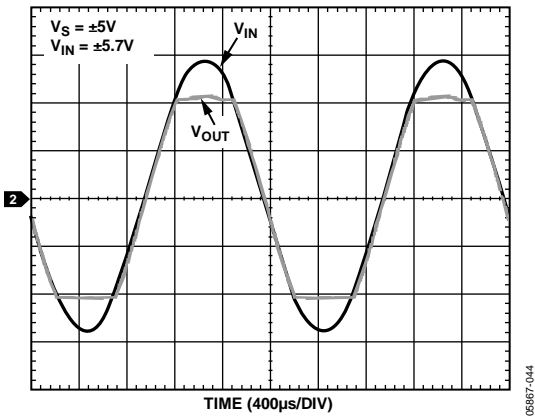
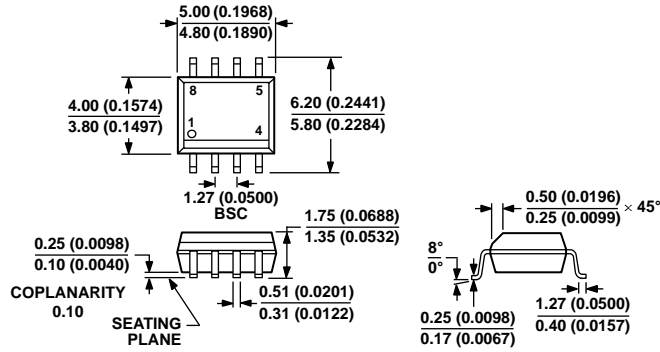

Figure 40. No Phase Reversal

OUTLINE DIMENSIONS



COMPLIANT TO JEDEC STANDARDS MS-012-AA
 CONTROLLING DIMENSIONS ARE IN MILLIMETERS; INCH DIMENSIONS
 (IN PARENTHESES) ARE ROUNDED-OFF MILLIMETER EQUIVALENTS FOR
 REFERENCE ONLY AND ARE NOT APPROPRIATE FOR USE IN DESIGN.

012407-A

Figure 43. 8-Lead Standard Small Outline Package [SOIC_N]
 Narrow Body
 (R-8)

Dimensions shown in millimeters and (inches)

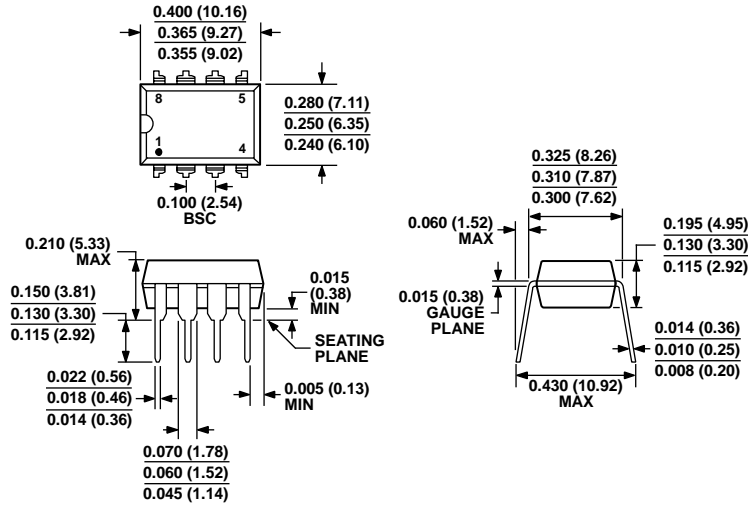

COMPLIANT TO JEDEC STANDARDS MS-001
 CONTROLLING DIMENSIONS ARE IN INCHES; MILLIMETER DIMENSIONS
 (IN PARENTHESES) ARE ROUNDED-OFF INCH EQUIVALENTS FOR
 REFERENCE ONLY AND ARE NOT APPROPRIATE FOR USE IN DESIGN.
 CORNER LEADS MAY BE CONFIGURED AS WHOLE OR HALF LEADS.

070506-A

Figure 44. 8-Lead Plastic Dual In-Line Package [PDIP]
 (N-8)

Dimensions shown in inches and (millimeters)

OP07D

ORDERING GUIDE

Model ¹	Temperature Range	Package Description	Package Option
OP07DNZ	-40°C to +125°C	8-Lead PDIP	N-8
OP07DRZ	-40°C to +125°C	8-Lead SOIC_N	R-8
OP07DRZ-REEL	-40°C to +125°C	8-Lead SOIC_N	R-8
OP07DRZ-REEL7	-40°C to +125°C	8-Lead SOIC_N	R-8

¹ Z = RoHS Compliant Part.

NOTES

OP07D

NOTES

Mouser Electronics

Authorized Distributor

Click to View Pricing, Inventory, Delivery & Lifecycle Information:

[Analog Devices Inc.:](#)

[OP07DRZ-REEL](#) [OP07DRZ-REEL7](#) [OP07DNZ](#) [OP07DRZ](#)