

Photocouplers Photorelay

TLP3419

1. Applications

- ATE (Automatic Test Equipment)
- High-Speed Logic IC Testers
- High-Speed Memory Testers
- Measuring Instruments

2. General

The TOSHIBA TLP3419 is a very small outline non-leaded photorelay suitable for surface-mount assembly. The TLP3419 consists of an infrared LED optically coupled to a photo-MOSFET and is housed in a VSON 4-pin package. The TLP3419 is suitable for applications that require low output capacitance and high withstand voltage, such as LCD testers.

3. Features

- (1) Normally opened (1-Form-A)
- (2) OFF-state output terminal voltage: 80 V (min)
- (3) Trigger LED current: 3 mA (max)
- (4) ON-state current: 200 mA (max)
- (5) ON-state resistance: 6 Ω (typ.), 8 Ω (max)
- (6) Output capacitance: 6.5 pF(typ.), 11 pF(max)
- (7) Isolation voltage: 500 Vrms (min)

4. Packaging and Pin Assignment

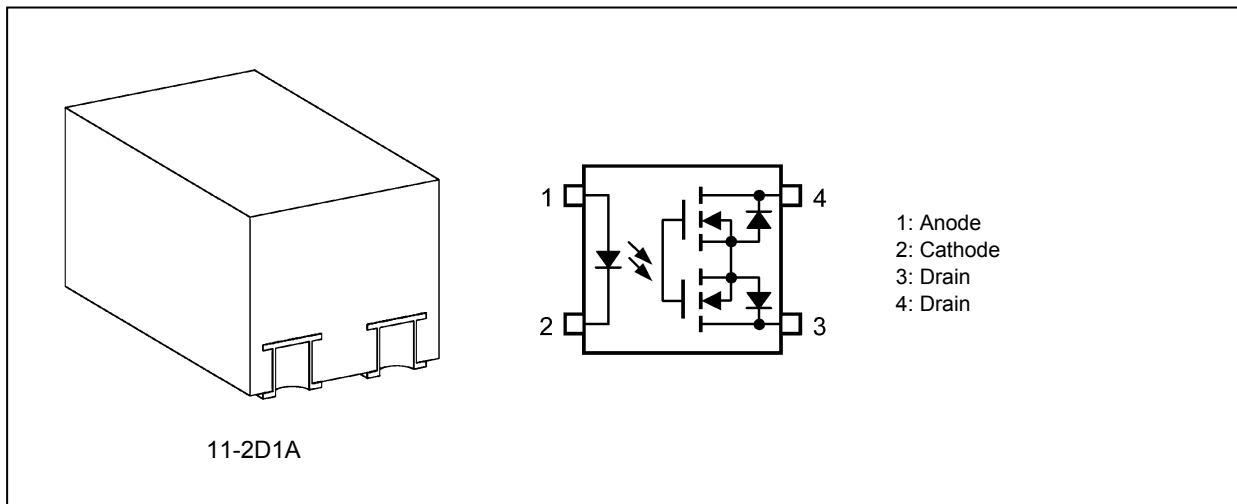

Start of commercial production

2015-02

5. Internal Circuit

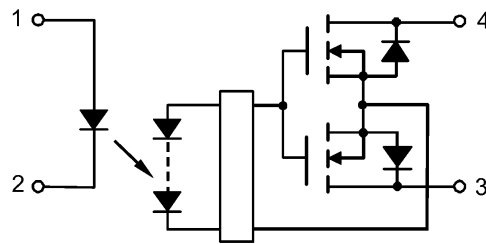

6. Absolute Maximum Ratings (Note) (Unless otherwise specified, $T_a = 25\text{ }^\circ\text{C}$)

	Characteristics	Symbol	Note	Rating	Unit
LED	Input forward current	I_F		30	mA
	Input forward current derating ($T_a \geq 25\text{ }^\circ\text{C}$)	$\Delta I_F/\Delta T_a$		-0.3	mA/ $^\circ\text{C}$
	Input reverse voltage	V_R		5	V
	Input power dissipation	P_D		50	mW
	Input power dissipation derating ($T_a \geq 25\text{ }^\circ\text{C}$)	$\Delta P_D/\Delta T_a$		-0.5	mW/ $^\circ\text{C}$
	Junction temperature	T_j		125	$^\circ\text{C}$
Detector	OFF-state output terminal voltage	V_{OFF}		80	V
	ON-state current	I_{ON}		200	mA
	ON-state current derating ($T_a \geq 25\text{ }^\circ\text{C}$)	$\Delta I_{ON}/\Delta T_a$		-2	mA/ $^\circ\text{C}$
	ON-state current (pulsed) ($t = 100\text{ ms}$, Duty = 1/10)	I_{ONP}		600	mA
	Output power dissipation	P_O		320	mW
	Output power dissipation derating ($T_a \geq 25\text{ }^\circ\text{C}$)	$\Delta P_O/\Delta T_a$		-3.2	mW/ $^\circ\text{C}$
	Junction temperature	T_j		125	$^\circ\text{C}$
Common	Storage temperature	T_{stg}		-40 to 125	
	Operating temperature	T_{opr}		-40 to 110	
	Lead soldering temperature (10 s)	T_{sol}		260	
	Isolation voltage AC, 60 s, R.H. $\leq 60\%$	BV_S	(Note 1)	500	Vrms

Note: Using continuously under heavy loads (e.g. the application of high temperature/current/voltage and the significant change in temperature, etc.) may cause this product to decrease in the reliability significantly even if the operating conditions (i.e. operating temperature/current/voltage, etc.) are within the absolute maximum ratings.

Please design the appropriate reliability upon reviewing the Toshiba Semiconductor Reliability Handbook ("Handling Precautions"/"Derating Concept and Methods") and individual reliability data (i.e. reliability test report and estimated failure rate, etc.).

Note 1: This device is considered as a two-terminal device: Pins 1 and 2 are shorted together, and pins 3 and 4 are shorted together.

Note: This device is sensitive to electrostatic discharge (ESD). Extreme ESD conditions should be guarded against by using proper antistatic precautions for the worktable, operator, solder iron, soldering equipment and so on.

7. Recommended Operating Conditions (Note)

Characteristics	Symbol	Note	Min	Typ.	Max	Unit
Supply voltage	V_{DD}		—	—	64	V
Input forward current	I_F		5	7.5	20	mA
ON-state current	I_{ON}		—	—	200	mA
Operating temperature	T_{opr}		-20	—	85	$^\circ\text{C}$

Note: The recommended operating conditions are given as a design guide necessary to obtain the intended performance of the device. Each parameter is an independent value. When creating a system design using this device, the electrical characteristics specified in this data sheet should also be considered.

8. Electrical Characteristics (Unless otherwise specified, $T_a = 25\text{ }^\circ\text{C}$)

	Characteristics	Symbol	Note	Test Condition	Min	Typ.	Max	Unit
LED	Input forward voltage	V_F		$I_F = 10\text{ mA}$	1.1	1.27	1.4	V
	Input reverse current	I_R		$V_R = 5\text{ V}$	—	—	10	μA
	Input capacitance	C_t		$V = 0\text{ V}, f = 1\text{ MHz}$	—	30	—	pF
Detector	OFF-state current	I_{OFF}		$V_{OFF} = 80\text{ V}$	—	—	1	nA
	Output capacitance	C_{OFF}		$V = 0\text{ V}, f = 100\text{ MHz}, t < 1\text{ s}$	—	6.5	11	pF

9. Coupled Electrical Characteristics (Unless otherwise specified, $T_a = 25\text{ }^\circ\text{C}$)

	Characteristics	Symbol	Note	Test Condition	Min	Typ.	Max	Unit
Trigger LED current		I_{FT}		$I_{ON} = 100\text{ mA}$	—	1.1	3	mA
	Return LED current	I_{FC}		$I_{OFF} = 10\text{ }\mu\text{A}$	0.1	—	—	
ON-state resistance		R_{ON}		$I_{ON} = 200\text{ mA}, I_F = 5\text{ mA}, t < 1\text{ s}$	—	6	8	Ω

10. Isolation Characteristics (Unless otherwise specified, $T_a = 25\text{ }^\circ\text{C}$)

	Characteristics	Symbol	Note	Test Condition	Min	Typ.	Max	Unit
Total capacitance (input to output)		C_S	(Note 1)	$V_S = 0\text{ V}, f = 1\text{ MHz}$	—	1	—	pF
Isolation resistance		R_S	(Note 1)	$V_S = 500\text{ V}, R.H. \leq 60\%$	—	10^{14}	—	Ω
Isolation voltage		BV_S	(Note 1)	AC, 60 s	500	—	—	Vrms

Note 1: This device is considered as a two-terminal device: Pins 1 and 2 are shorted together, and pins 3 and 4 are shorted together.

11. Switching Characteristics (Unless otherwise specified, $T_a = 25\text{ }^\circ\text{C}$)

	Characteristics	Symbol	Note	Test Condition	Min	Typ.	Max	Unit
Turn-on time		t_{ON}		See Fig. 11.1. $R_L = 200\text{ }\Omega, V_{DD} = 20\text{ V}, I_F = 5\text{ mA}$	—	130	400	μs
Turn-off time		t_{OFF}			—	20	400	

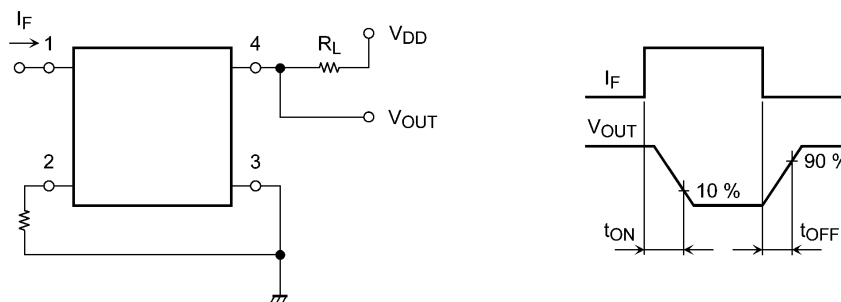

Fig. 11.1 Switching Time Test Circuit and Waveform

12. Characteristics Curves (Note)

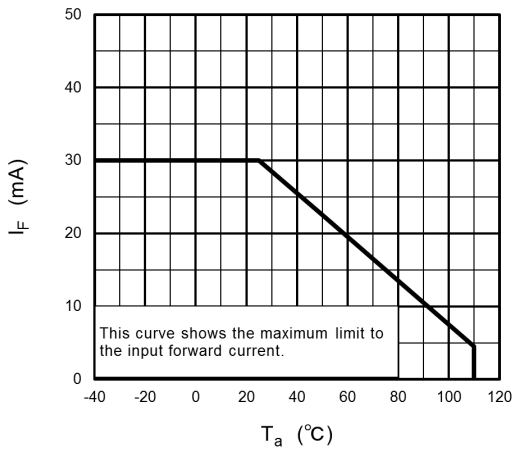

Fig. 12.1 $I_F - T_a$

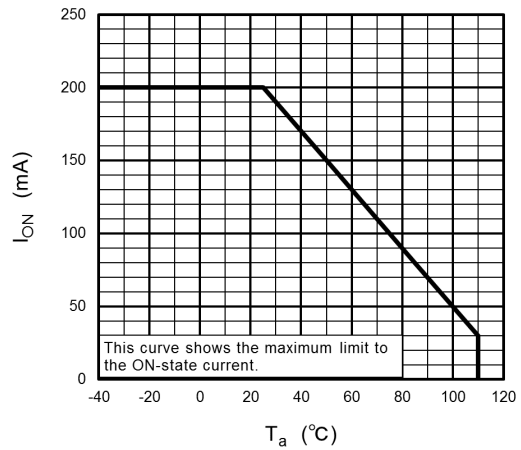

Fig. 12.2 $I_{ON} - T_a$

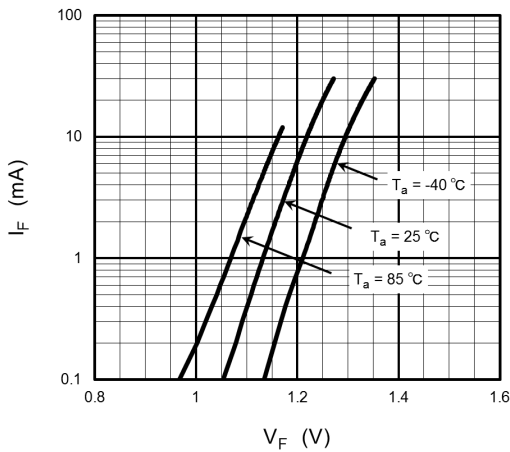

Fig. 12.3 $I_F - V_F$

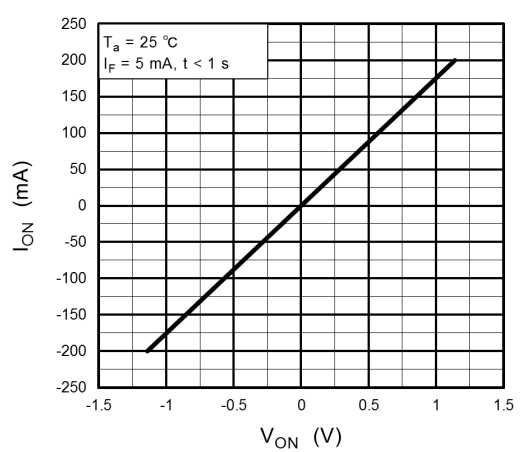

Fig. 12.4 $I_{ON} - V_{ON}$

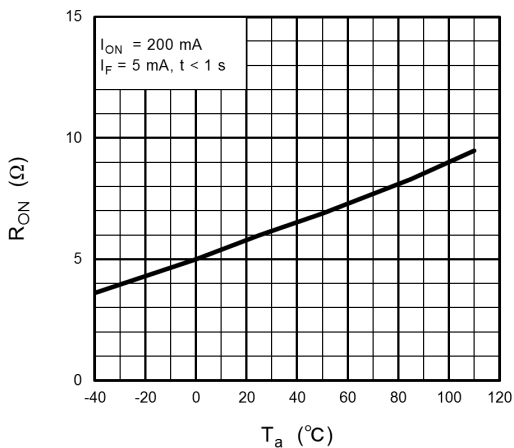

Fig. 12.5 $R_{ON} - T_a$

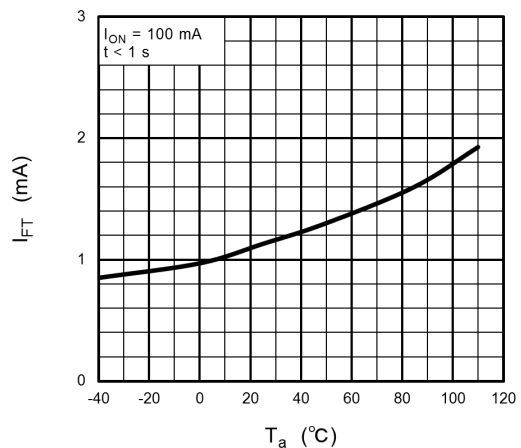

Fig. 12.6 $I_{FT} - T_a$

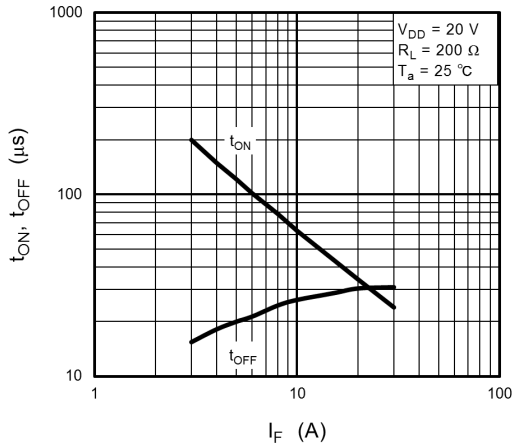

Fig. 12.7 $t_{ON}, t_{OFF} - I_F$

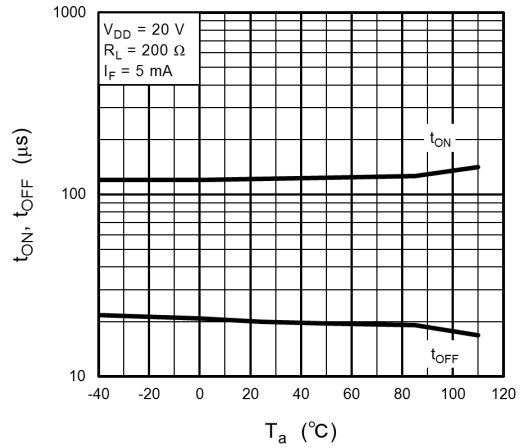

Fig. 12.8 $t_{ON}, t_{OFF} - T_a$

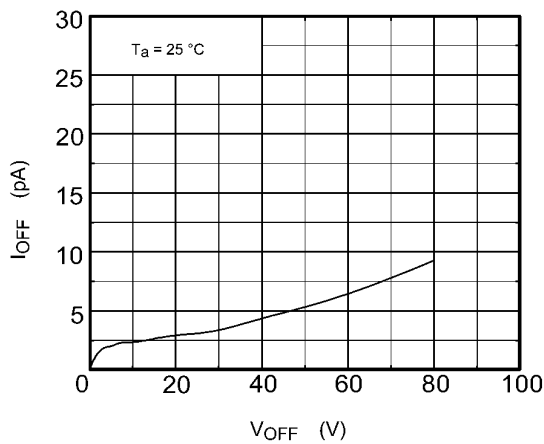

Fig. 12.9 $I_{OFF} - V_{OFF}$

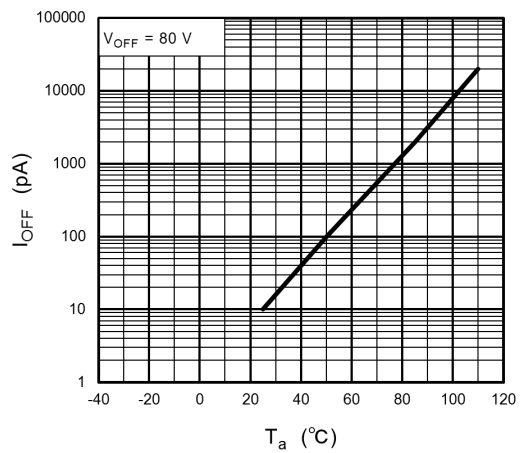

Fig. 12.10 $I_{OFF} - T_a$

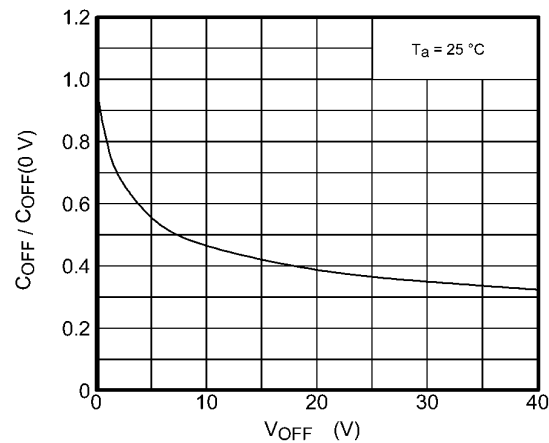

Fig. 12.11 $C_{OFF}/C_{OFF(0 V)} - V_{OFF}$

Note: The above characteristics curves are presented for reference only and not guaranteed by production test, unless otherwise noted.

13. Soldering and Storage

13.1. Precautions for Soldering

The soldering temperature should be controlled as closely as possible to the conditions shown below.

- When using soldering reflow

(See the figure shown below, which is based on the package surface temperature.)

Reflow soldering may be performed up to twice.

The first reflow soldering should be performed within 168 hours after opening the moisture-proof packaging.

The second reflow soldering must be performed within 168 hours of the first reflow.

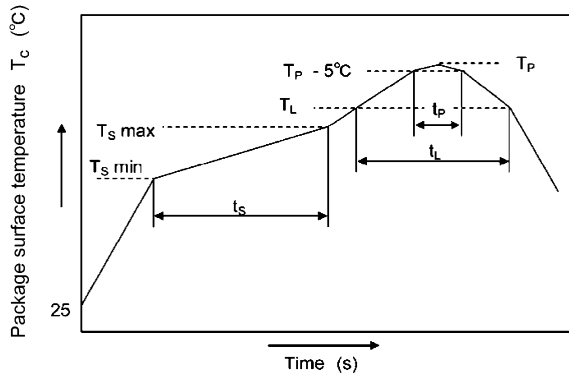

	Symbol	Min	Max	Unit
Preheat temperature	T_s	150	200	$^\circ\text{C}$
Preheat time	t_s	60	120	s
Ramp-up rate (T_L to T_P)			3	$^\circ\text{C/s}$
Liquidus temperature	T_L	217		$^\circ\text{C}$
Time above T_L	t_L	60	150	s
Peak temperature	T_P		260	$^\circ\text{C}$
Time during which T_c is between ($T_P - 5$) and T_P	t_p		30	s
Ramp-down rate (T_P to T_L)			6	$^\circ\text{C/s}$

- When using soldering Iron

Complete soldering within 10 seconds for lead temperature not exceeding 260°C .

Heating by soldering iron must be done only once per lead.

13.2. Precautions for General Storage

- Avoid storage locations where devices may be exposed to moisture or direct sunlight.
- Do not store the products in locations with poisonous gases (especially corrosive gases) or in dusty conditions.
- Store the products in locations with minimal temperature fluctuations. Rapid temperature changes during storage can cause condensation, resulting in lead oxidation or corrosion, which will deteriorate the solderability of the leads.
- Do not allow loads to be applied directly to devices while they are in storage.
- If devices have been stored for more than two years under normal storage conditions, it is recommended that you check the leads for ease of soldering prior to use.
- Follow the precautions printed on the packing label of the device for transportation and storage.
- Thermal stress may cause a crack in surface-mount products during surface-mount assembly if they have absorbed atmospheric moisture. To prevent a crack, please observe the following precautions.
 1. Moisture-proof bags may be stored unopened for up to 12 months under the following conditions.
 - Temperature: 5 °C to 30 °C
 - Humidity: 90 % (max)
 2. After opening the moisture-proof bag, the devices should be assembled within 168 hours in an environment of 5 °C to 30 °C/70 %RH or below.
 3. If, upon opening, the moisture indicator card shows a humidity of 30 % or above (i.e., has turned pink) or the expiration date has passed, the devices should be baked in tape and reel.

After baking, use the baked devices within 72 hours, but perform baking only once.

 - Baking conditions: 60±5 °C, for 64 to 72 hours.
 - Expiration date: 12 months from the sealing date, which is imprinted on the label affixed.
 4. Repeated baking can affect the peeling strength of taping and cause a trouble during mounting.

Furthermore, protect the devices against static electricity for baking.
 5. If the laminated packing material is broken, its hermeticity deteriorates. Therefore, do not throw or drop the packed devices.
 6. When restoring devices after removal from their packing, use anti-static containers.

14. Land Pattern Dimensions (for reference only)

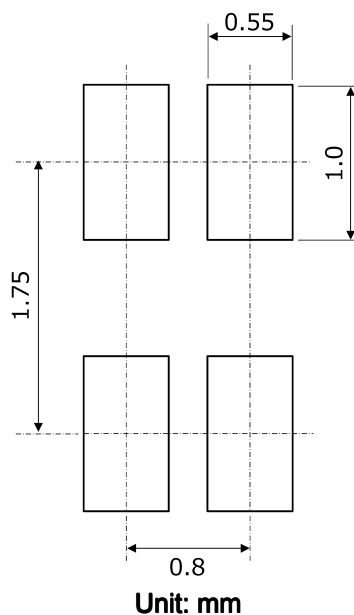

15. Marking

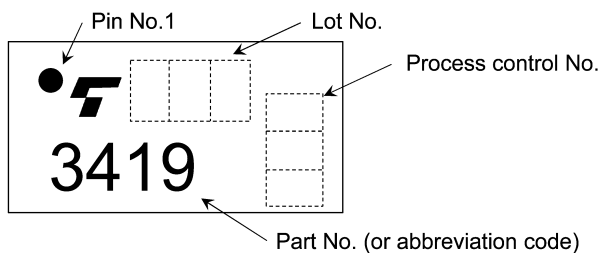

16. Ordering Information

When placing an order, please specify the part number, tape type and quantity as shown in the following example.

Example) TLP3419(TP,F 3000 pcs

Part number: TLP3419

Tape type: TP

[[G]]/RoHS COMPATIBLE: F (Note 1)

Quantity (must be a multiple of 3000): 3000 pcs

Note 1: Please contact your Toshiba sales representative for details on environmental information such as the product's RoHS compatibility.

RoHS is the Directive 2011/65/EU of the European Parliament and of the Council of 8 June 2011 on the restriction of the use of certain hazardous substances in electrical and electronic equipment.

Package Dimensions

Unit: mm

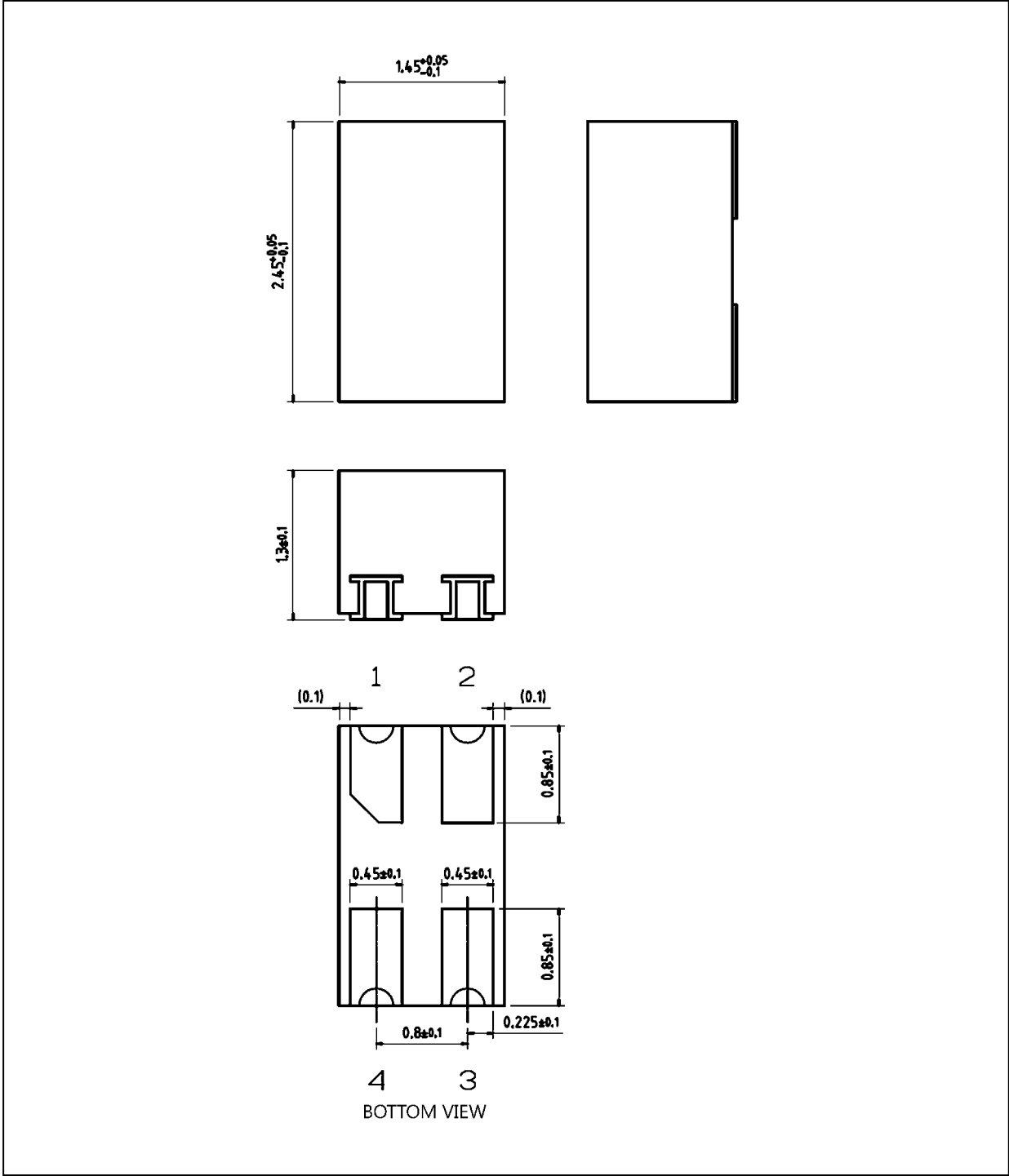

Weight: 10 mg (typ.)

Package Name(s)
TOSHIBA: 11-2D1A

RESTRICTIONS ON PRODUCT USE

Toshiba Corporation and its subsidiaries and affiliates are collectively referred to as "TOSHIBA".

Hardware, software and systems described in this document are collectively referred to as "Product".

- TOSHIBA reserves the right to make changes to the information in this document and related Product without notice.
- This document and any information herein may not be reproduced without prior written permission from TOSHIBA. Even with TOSHIBA's written permission, reproduction is permissible only if reproduction is without alteration/omission.
- Though TOSHIBA works continually to improve Product's quality and reliability, Product can malfunction or fail. Customers are responsible for complying with safety standards and for providing adequate designs and safeguards for their hardware, software and systems which minimize risk and avoid situations in which a malfunction or failure of Product could cause loss of human life, bodily injury or damage to property, including data loss or corruption. Before customers use the Product, create designs including the Product, or incorporate the Product into their own applications, customers must also refer to and comply with (a) the latest versions of all relevant TOSHIBA information, including without limitation, this document, the specifications, the data sheets and application notes for Product and the precautions and conditions set forth in the "TOSHIBA Semiconductor Reliability Handbook" and (b) the instructions for the application with which the Product will be used with or for. Customers are solely responsible for all aspects of their own product design or applications, including but not limited to (a) determining the appropriateness of the use of this Product in such design or applications; (b) evaluating and determining the applicability of any information contained in this document, or in charts, diagrams, programs, algorithms, sample application circuits, or any other referenced documents; and (c) validating all operating parameters for such designs and applications.
TOSHIBA ASSUMES NO LIABILITY FOR CUSTOMERS' PRODUCT DESIGN OR APPLICATIONS.

- **PRODUCT IS NEITHER INTENDED NOR WARRANTED FOR USE IN EQUIPMENTS OR SYSTEMS THAT REQUIRE EXTRAORDINARILY HIGH LEVELS OF QUALITY AND/OR RELIABILITY, AND/OR A MALFUNCTION OR FAILURE OF WHICH MAY CAUSE LOSS OF HUMAN LIFE, BODILY INJURY, SERIOUS PROPERTY DAMAGE AND/OR SERIOUS PUBLIC IMPACT ("UNINTENDED USE").**

Except for specific applications as expressly stated in this document, Unintended Use includes, without limitation, equipment used in nuclear facilities, equipment used in the aerospace industry, lifesaving and/or life supporting medical equipment, equipment used for automobiles, trains, ships and other transportation, traffic signaling equipment, equipment used to control combustions or explosions, safety devices, elevators and escalators, and devices related to power plant.

IF YOU USE PRODUCT FOR UNINTENDED USE, TOSHIBA ASSUMES NO LIABILITY FOR PRODUCT.

For details, please contact your TOSHIBA sales representative or contact us via our website.

- Do not disassemble, analyze, reverse-engineer, alter, modify, translate or copy Product, whether in whole or in part.
- Product shall not be used for or incorporated into any products or systems whose manufacture, use, or sale is prohibited under any applicable laws or regulations.
- The information contained herein is presented only as guidance for Product use. No responsibility is assumed by TOSHIBA for any infringement of patents or any other intellectual property rights of third parties that may result from the use of Product. No license to any intellectual property right is granted by this document, whether express or implied, by estoppel or otherwise.
- **ABSENT A WRITTEN SIGNED AGREEMENT, EXCEPT AS PROVIDED IN THE RELEVANT TERMS AND CONDITIONS OF SALE FOR PRODUCT, AND TO THE MAXIMUM EXTENT ALLOWABLE BY LAW, TOSHIBA (1) ASSUMES NO LIABILITY WHATSOEVER, INCLUDING WITHOUT LIMITATION, INDIRECT, CONSEQUENTIAL, SPECIAL, OR INCIDENTAL DAMAGES OR LOSS, INCLUDING WITHOUT LIMITATION, LOSS OF PROFITS, LOSS OF OPPORTUNITIES, BUSINESS INTERRUPTION AND LOSS OF DATA, AND (2) DISCLAIMS ANY AND ALL EXPRESS OR IMPLIED WARRANTIES AND CONDITIONS RELATED TO SALE, USE OF PRODUCT, OR INFORMATION, INCLUDING WARRANTIES OR CONDITIONS OF MERCHANTABILITY, FITNESS FOR A PARTICULAR PURPOSE, ACCURACY OF INFORMATION, OR NONINFRINGEMENT.**
- GaAs (Gallium Arsenide) is used in Product. GaAs is harmful to humans if consumed or absorbed, whether in the form of dust or vapor. Handle with care and do not break, cut, crush, grind, dissolve chemically or otherwise expose GaAs in Product.
- Do not use or otherwise make available Product or related software or technology for any military purposes, including without limitation, for the design, development, use, stockpiling or manufacturing of nuclear, chemical, or biological weapons or missile technology products (mass destruction weapons). Product and related software and technology may be controlled under the applicable export laws and regulations including, without limitation, the Japanese Foreign Exchange and Foreign Trade Law and the U.S. Export Administration Regulations. Export and re-export of Product or related software or technology are strictly prohibited except in compliance with all applicable export laws and regulations.
- Please contact your TOSHIBA sales representative for details as to environmental matters such as the RoHS compatibility of Product. Please use Product in compliance with all applicable laws and regulations that regulate the inclusion or use of controlled substances, including without limitation, the EU RoHS Directive. **TOSHIBA ASSUMES NO LIABILITY FOR DAMAGES OR LOSSES OCCURRING AS A RESULT OF NONCOMPLIANCE WITH APPLICABLE LAWS AND REGULATIONS.**

Mouser Electronics

Authorized Distributor

Click to View Pricing, Inventory, Delivery & Lifecycle Information:

Toshiba:

[TLP3419\(TP,F\)](#) [TLP3419TP,FO](#) [TLP3419\(TP,F\)](#)